STANLEY®



MERCHANDISING AND DISPLAY SYSTEM

THE MEASURE OF A PRO™

STANLEY®

HARD BEAT

PRO FEATURES. ENGINEERED FOR THE TRADE.

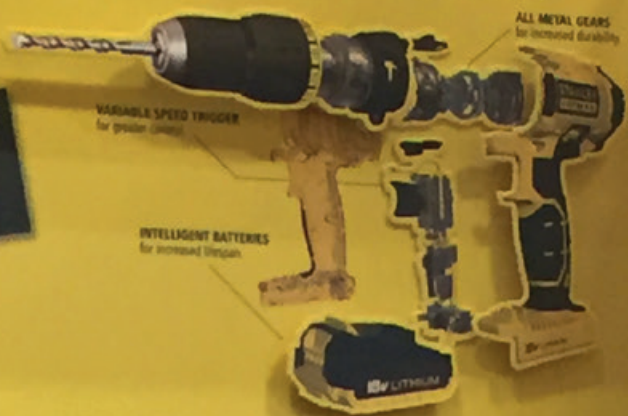

750W SDS-PLUS HAMMER DRILL 3 YEAR WARRANTY \$92

12V IMPACT DRIVER 3 YEAR WARRANTY \$108

12V HAMMER DRILL 3 YEAR WARRANTY \$95

750W SDS-PLUS HAMMER DRILL AND SCREWDRIVER RECHARGEABLE KIT 3 YEAR WARRANTY \$122



1650W 190MM CIRCULAR SAW 3 YEAR WARRANTY \$87

710W RECIPROCATING SAW 3 YEAR WARRANTY \$65

300W OSCILLATING MULTI TOOL 3 YEAR WARRANTY \$87

900W RECIPROCATING SAW 3 YEAR WARRANTY \$80

ENGINEERED FOR THE TRADE

3 YEAR WARRANTY



CONTENTS

MERCHANDISING AND DISPLAY SYSTEM

4
WALL DISPLAYS

16
INNOCENTRES

26
FREESTANDING UNITS

42
COUNTER TOP UNITS

50
SPECIALIST DISPLAYS

78
COMPONENTS

88
HOOKS & TOOL HOLDERS

108
COMMUNICATION

116
SPECIAL ORDER ITEMS





WALL DISPLAYS



WALL DISPLAYS PEGBOARD

Incorporates front fluorescent illumination behind 2-D logo panel.

ILLUMINATED STAND-ALONE FIXTURES



Hooks to be ordered separately - Catalogue page 74

ILLUMINATED STAND-ALONE FIXTURE - PEGBOARD

CODE	DESCRIPTION	DIMENSIONS	PRICE
MC62422-XJ	1250mm Illuminated Stand-Alone Fixture - Pegboard	1280mm W 2233mm H 541mm D	243,76 \$
STHT8-98807	1000mm Illuminated Stand-Alone Fixture - Pegboard	1030mm W 2233mm H 541mm D	217,09 \$
STHT8-98808	900mm Illuminated Stand-Alone Fixture - Pegboard	923mm W 2233mm H 710mm D	221,94 \$

ILLUMINATED ADD-ON STANDS

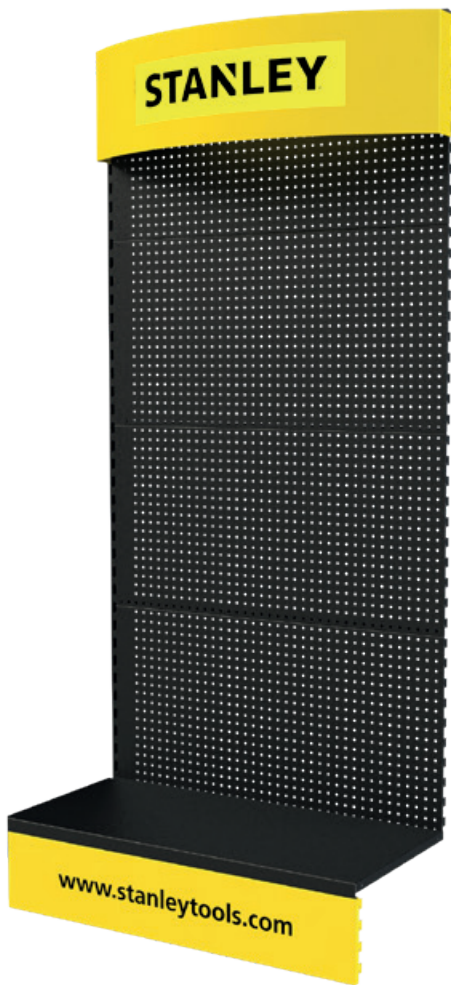

ILLUMINATED ADD-ON STANDS - PEGBOARD

CODE	DESCRIPTION	DIMENSIONS	PRICE
MC62423-XJ	1250mm Illuminated Add On Stand - Pegboard	1261mm W 2233mm H 541mm D	226.98 \$
STHT8-98809	1000mm Illuminated Add On Stand - Pegboard	1015mm W 2233mm H 541mm D	196.23 \$
STHT8-98810	900mm Illuminated Add On Stand - Pegboard	915mm W 2233mm H 710mm D	201.08 \$

MAIN UNIT EXAMPLE

ILLUMINATED FIXTURE - PEGBOARD

ORDER QTY	ITEM
1	Stand-Alone Fixture
2	Add On Stand

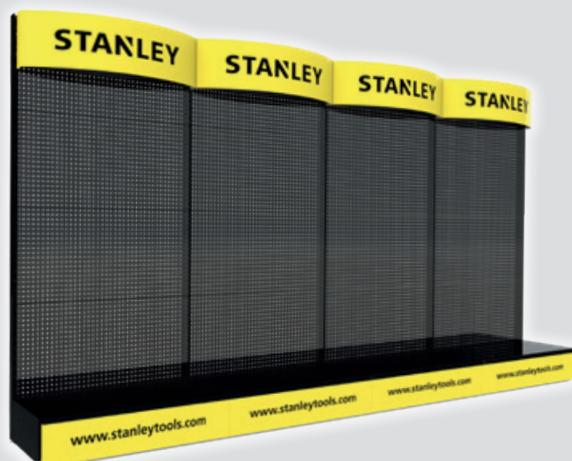
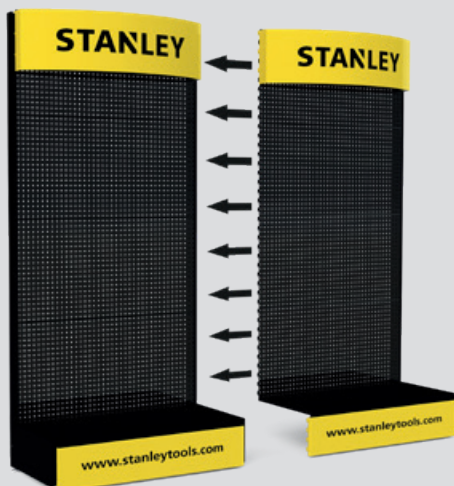

WALL DISPLAYS PEGBOARD

NON-ILLUMINATED STAND-ALONE FIXTURES



Hooks to be ordered
separately - Catalogue page 74

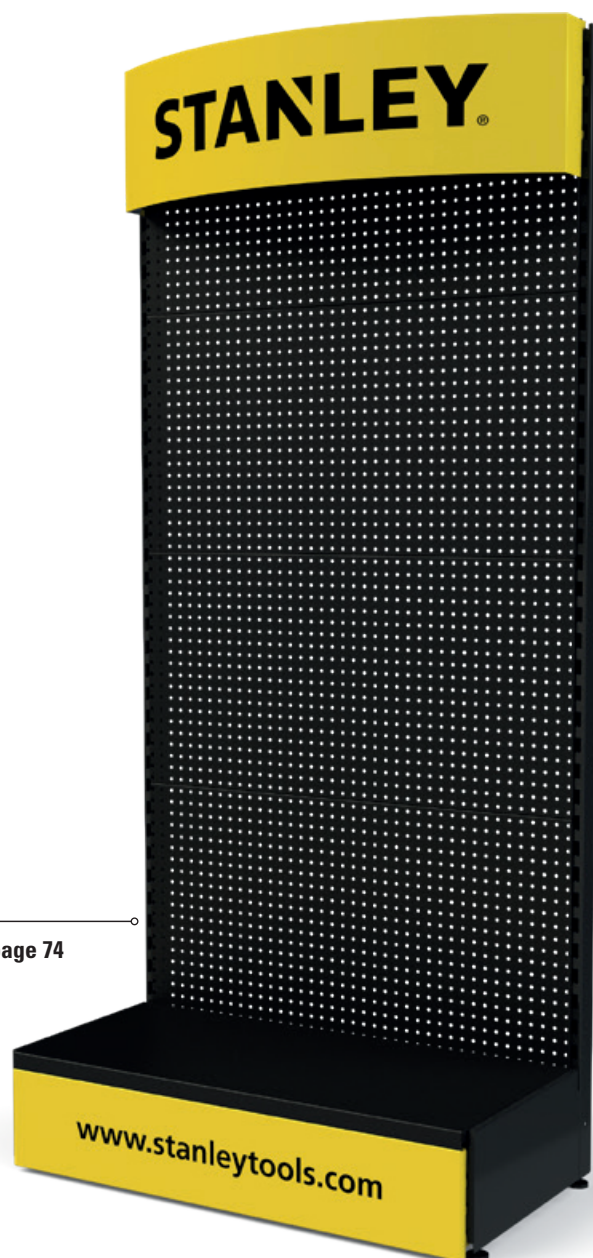

NON-ILLUMINATED STAND-ALONE FIXTURES

CODE	DESCRIPTION	DIMENSIONS	PRICE
MS99034-XJ	1250mm Non-Illuminated Stand-Alone Fixture - Pegboard	1280mm W 2233mm H 541mm D	208,55 \$
MC03861-XJ	1000mm Non-Illuminated Stand-Alone Fixture - Pegboard	1030mm W 2233mm H 541mm D	181,88 \$

NON-ILLUMINATED ADD-ON STANDS



NON-ILLUMINATED ADD-ON STANDS

CODE	DESCRIPTION	DIMENSIONS	PRICE
MC03869-XJ	1000mm Non-Illuminated Add On Stand - Pegboard	1015mm W 2233mm H 541mm D	161.05 \$

MAIN UNIT EXAMPLE

NON-ILLUMINATED ADD-ON STANDS - PEGBOARD

ORDER QTY	ITEM
1	Stand-Alone Fixture
2	Add On Stand

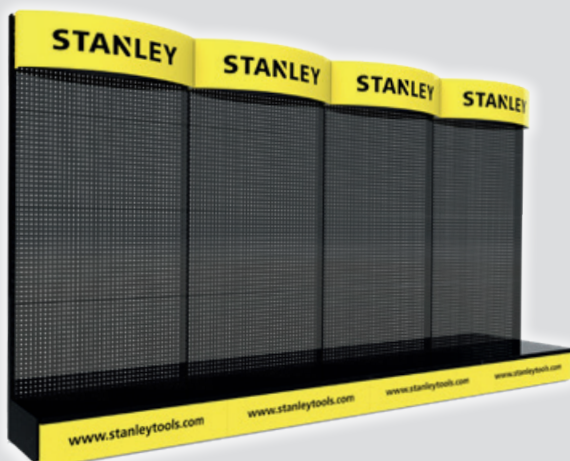
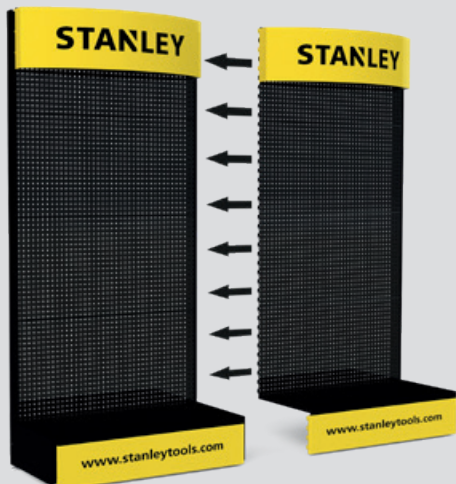

STAND-ALONE STAND

500mm PEGBOARD STAND-ALONE STAND



500mm PEGBOARD STAND-ALONE STAND

CODE	DESCRIPTION	DIMENSIONS	PRICE
MS99038-XJ	500mm Pegboard Stand-Alone Stand	513mm W 2233mm H 541mm D	119.75 \$

500mm PEGBOARD ADD-ON STAND



500mm PEGBOARD ADD-ON STAND

CODE	DESCRIPTION	DIMENSIONS	PRICE
MS99039-XJ	500mm Pegboard Add-On Stand	514mm W 2233mm H 541mm D	90.94 \$

MAIN UNIT EXAMPLE

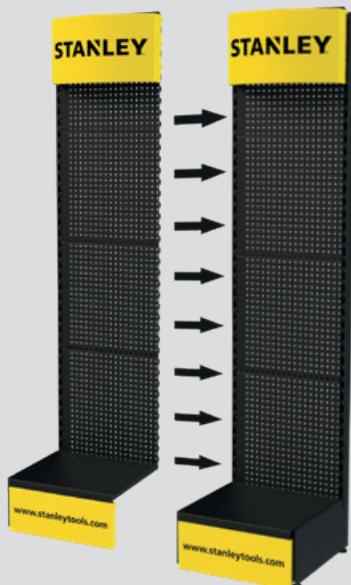

500mm STANDS - PEGBOARD

ORDER QTY	ITEM
1	Stand-Alone Fixture
2	Add On Stand



CORNER COMPONENTS

EXTERNAL



INTERNAL

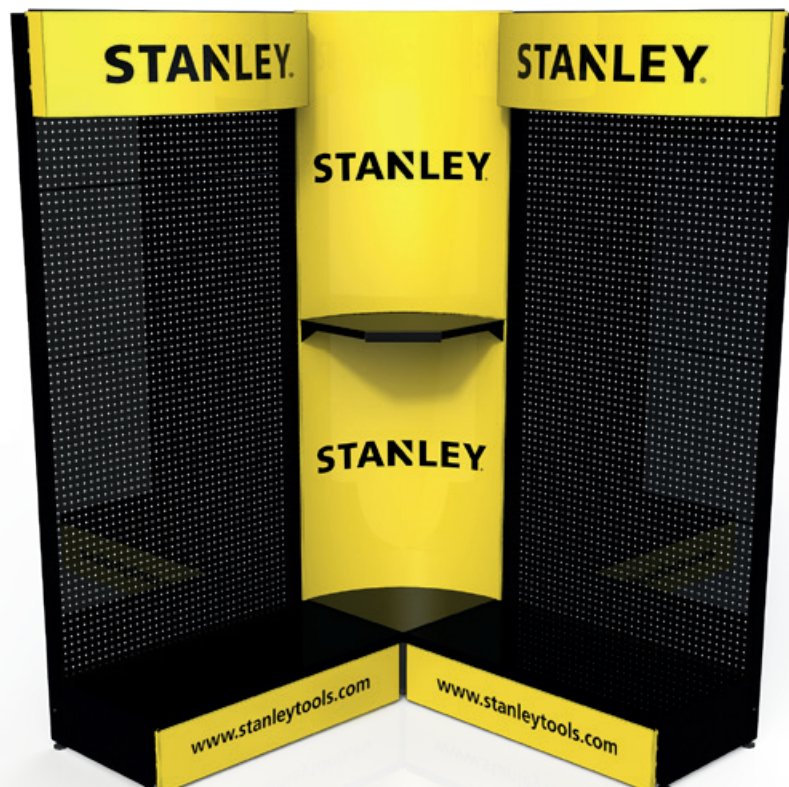

300mm CORNER SHELF



300mm CORNER SHELF

CODE	DESCRIPTION	DIMENSIONS	PRICE
STHT8-98824	300mm Corner Shelf	714mm W 74mm H 367mm D	16.05 \$
STHT8-98857	300mm Corner Shelf (Nordic)	970mm W 74mm H 450mm D	16.83 \$

EXTERNAL OR INTERNAL CORNER



EXTERNAL OR INTERNAL CORNER

CODE	DESCRIPTION	DIMENSIONS	PRICE
STHT8-98822	External or Internal Corner	542mm W 223mm H 542mm D	56.60 \$
STHT8-98823	External or Internal Corner (Nordic)	716mm W 223mm H 716mm D	59.36 \$

RADIUS PANEL - 2 PIECE - FOR INTERNAL CORNER



RADIUS PANEL - 2 PIECE - FOR INTERNAL CORNER

CODE	DESCRIPTION	DIMENSIONS	PRICE
STHT8-98825	Radius Panel - 2 piece - for internal corner	509mm W 994mm H 509mm D	61.60 \$
STHT8-98858	Radius Panel - 2 piece - for internal corner (Nordic)	964mm W 998mm H 216mm D	64.60 \$

SFM 1M PROSTACK DISPLAY

SFM 1M PROSTACK DISPLAY



SFM 1M PROSTACK DISPLAY

CODE	DESCRIPTION	DIMENSIONS	PRICE
MS99787-XJ	SFM 1M PROSTACK DISPLAY	1030mm W 2248mm H 541mm D	290.00 \$

SFM 2M PROSTACK DISPLAY



SFM 2M PROSTACK DISPLAY

CODE	DESCRIPTION	DIMENSIONS	PRICE
MS99788-XJ	SFM 2M PROSTACK DISPLAY (BOX 1)	1030mm W 2248mm H 541mm D	430.00 \$
MS99795-XJ	SFM 2M PROSTACK DISPLAY (BOX 2)	1030mm W 2248mm H 541mm D	0.00 \$

INNOCENTRES DISPLAY SYSTEM



M

DELUXE INNOCENTRE KIT POWERED

DELUXE INNOCENTRE KIT (POWERED STAND ALONE)

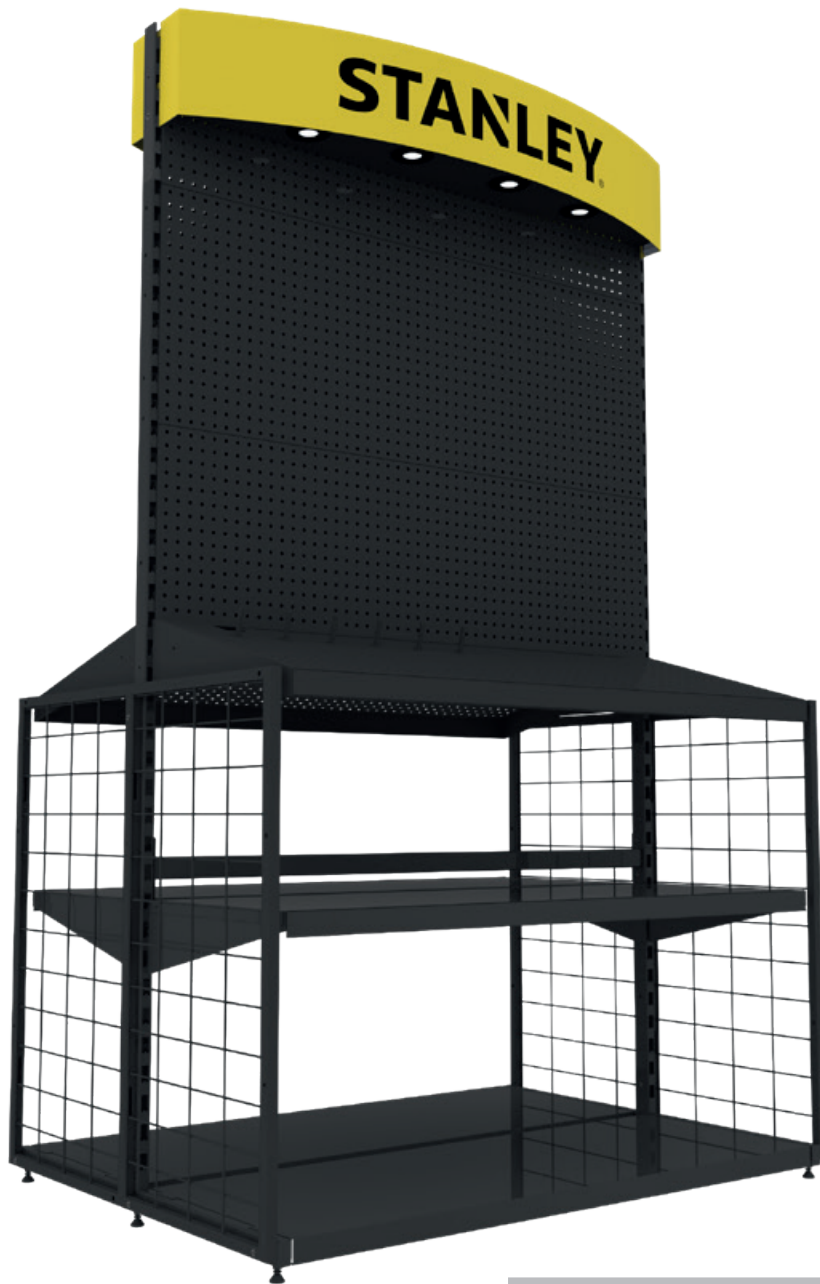

UNIVERSAL COMPONENTS INCLUDED

- 1245mm KD Header with Downlighters x2
- 850mm Upright x4
- 300mm Upright x2
- 450mm Base Leg x2
- Leg Extension x2
- 1220mm Rear Crossbar x2
- 1245mm x PEG Panel x4
- 300 x 1245 PEG Panel x2
- Angled Shelf x2
- 1245mm x 440mm Shelf x2
- 1245mm Base Shelf x2

DELUXE INNOCENTRE KIT (POWERED STAND ALONE)

CODE	DESCRIPTION	DIMENSIONS	PRICE
MS99101-XJ	Deluxe Innocentre Kit (Powered Stand Alone) Box1	1310mm W 2177mm H 938mm D	115.84 \$
MS99102-XJ	Deluxe Innocentre Kit (Powered Stand Alone) Box2	1310mm W 2177mm H 938mm D	115.84 \$
MS99103-XJ	Deluxe Innocentre Kit (Powered Stand Alone) Box3	1310mm W 2177mm H 938mm D	115.84 \$
MS99104-XJ	Deluxe Innocentre Kit (Powered Stand Alone) Box4	1310mm W 2177mm H 938mm D	115.84 \$

DELUXE INNOCENTRE KIT POWERED

A4 MAGNETIC POS HOLDER



Graphics supplied separately

A4 MAGNETIC POS HOLDER

CODE	DESCRIPTION	DIMENSIONS	PRICE
MC03987-XJ	A4 Magnetic POS Holder	298mm W 214mm H 2mm D	2.04 \$

A6 MAGNETIC POS HOLDER



Graphics supplied separately

A4 MAGNETIC POS HOLDER

CODE	DESCRIPTION	DIMENSIONS	PRICE
MP00664-QZ	A6 Magnetic POS Holder	150mm W 105mm H 4mm D	0.74 \$

STANLEY FATMAX MINI INNOCENTRE + TOOL HOLDERS

STANLEY FATMAX MINI INNOCENTRE + TOOL HOLDERS



Graphics supplied separately

COMPONENTS INCLUDED

- 2X Small Drill Holder
- 1X 200 x 160 Flat Shelf
- 1X Circular Saw Shelf
- 1X Pair Short Universal Tool Holders
- 1X Angle Grinder Holder
- 7X Product Display Posts
- 1X Battery Display Box

STANLEY FATMAX MINI INNOCENTRE + TOOL HOLDERS

CODE	DESCRIPTION	DIMENSIONS	PRICE
MC63153-FR	STANLEY FATMAX Mini Innocentre + Tool Holders	925mm W 1700mm H 489mm D	236.20 \$

MAIN UNIT EXAMPLE



PALLET INNOCENTRE

PALLET INNOCENTRE (NON-LINGUAL AND NON-ILLUMINATED)

Display includes 20X tool posts

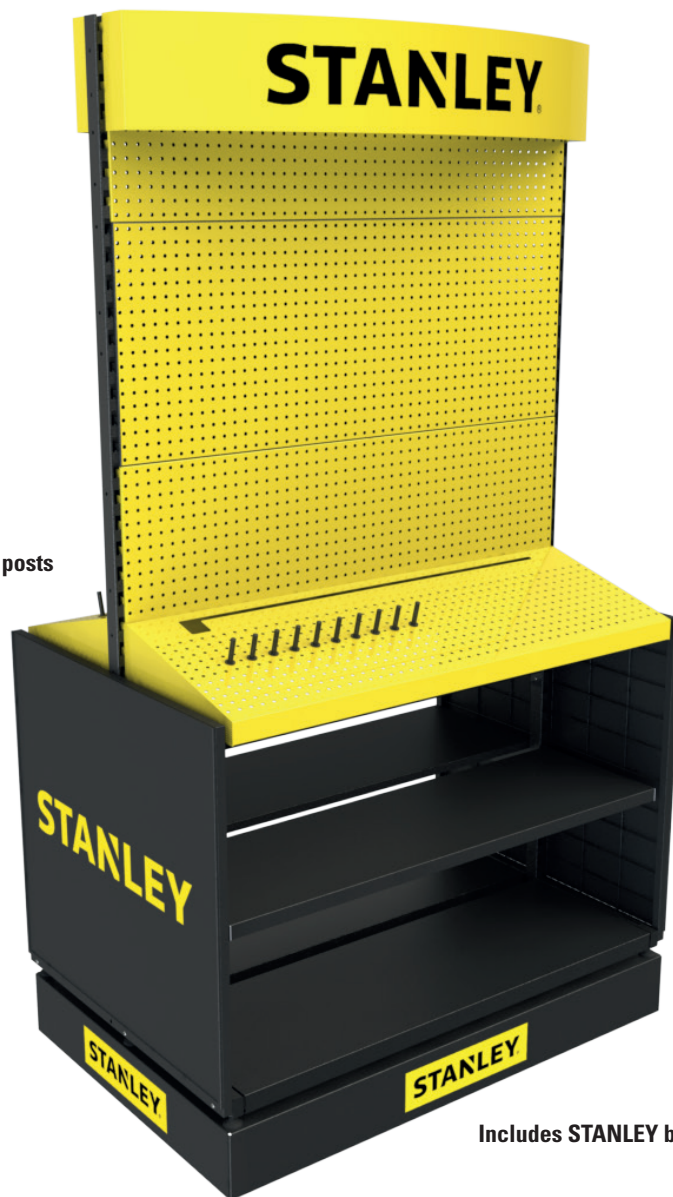

Includes STANLEY branded pallet cover

PALLET INNOCENTRE (NON-LINGUAL AND NON-ILLUMINATED)

CODE	DESCRIPTION	DIMENSIONS	PRICE
MS99343-XJ	STANLEY Pallet Innocentre (Non lingual and Non-illuminated)	1232mm W 2027mm H 800mm D	416.00 S

STANLEY PALLET INNOCENTRE SPINNERS

STANLEY PALLET INNOCENTRE SPINNERS



Graphics supplied separately

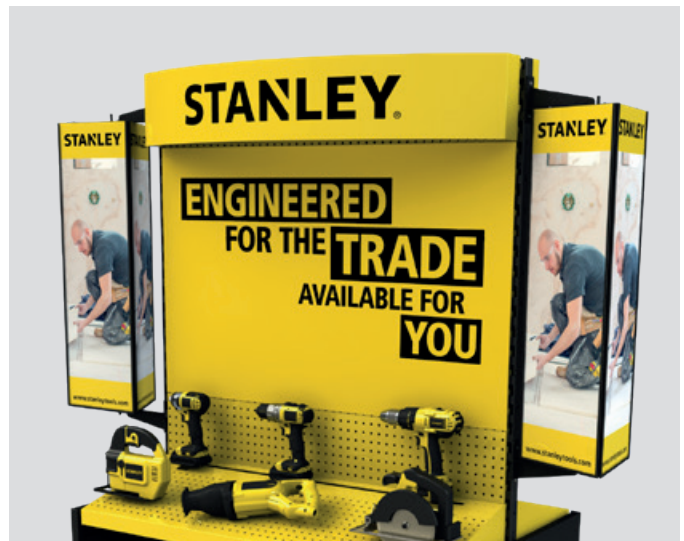

STANLEY PALLET INNOCENTRE SPINNERS

CODE	DESCRIPTION	DIMENSIONS	PRICE
MS99342-XJ	STANLEY Pallet Innocentre Spinners	290mm W 1023mm H 278mm D	76.60 \$

PALLET COVERS

SINGLE PALLET COVER



SINGLE PALLET COVER

CODE	DESCRIPTION	DIMENSIONS	PRICE
MS99123-XJ	Single Pallet Cover	1205mm W 806mm H 142mm D	16.00 \$

TRIPLE PALLET COVER



TRIPLE PALLET COVER			
CODE	DESCRIPTION	DIMENSIONS	PRICE
MS99124-XJ	Triple Pallet Cover	1205mm W 806mm H 426mm D	21.00 \$

FREESTANDING UNIT

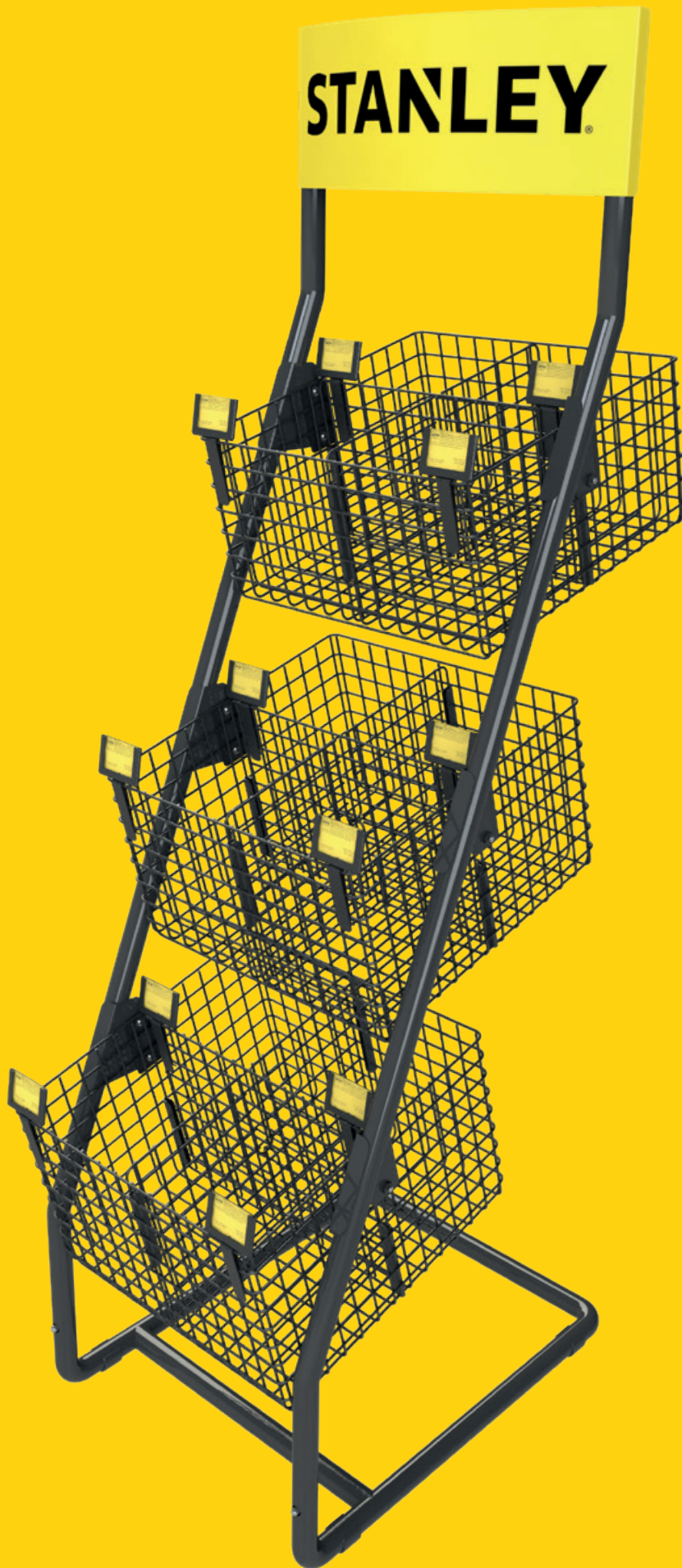

STANLEY Q-PALLET

STANLEY Q-PALLET



STANLEY Q-PALLET

CODE	DESCRIPTION	DIMENSIONS	PRICE
MC62173-XJ	Deluxe Innocentre Kit (Powered Stand Alone) Box1	427mm W 1571mm H 392mm D	55.82 \$

SAW HOLDER FOR Q-PALLET



SAW HOLDER FOR Q-PALLET

CODE	DESCRIPTION	DIMENSIONS	PRICE
MS99152-XJ	Saw Holder for Q-Pallet	387mm W 70mm H 200mm D	7.80 \$

Q-PALLET REAR PEGBOARD

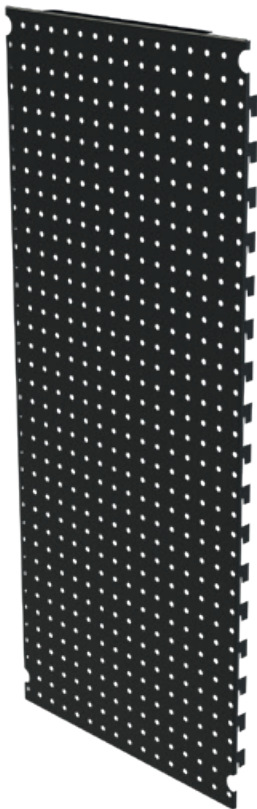

Q-PALLET REAR PEGBOARD

CODE	DESCRIPTION	DIMENSIONS	PRICE
MS99223-XJ	Q-Pallet Rear Pegboard	390mm W 940mm H 20mm D	14.50 \$

SIDE FRAME HOOK



SIDE FRAME HOOK

CODE	DESCRIPTION	DIMENSIONS	PRICE
MC62132-XJ	Side Frame Hook	40mm W 76mm H 172mm D	5.38 \$

STANLEY TOWER PREMIUM SHOP IN SHOP

STANLEY TOWER PREMIUM SHOP IN SHOP



UNIVERSAL COMPONENTS INCLUDED

- 1000mm KD Header x2
- 600mm KD Header x2
- 1000mm Downlighter Soffit x2
- 1000mm x Shelf x4
- 1000mm x PEG Panel x8
- 600mm x 500mm PEG Panel x4
- 600mm x 300mm PEG Panel x2
- 1000mm Rear Crossbar x1
- SAR Frame Extension Post x4
- SAR Side Frame x4
- Base Frame Bar x2
- 300mm Upright Extension x2
- 850mm Slotted Upright x4
- 19" Leg Extension x2
- 450mm Base Leg x2
- 1000mm Base Shelf x2

STANLEY TOWER PREMIUM SHOP IN SHOP

CODE	DESCRIPTION	DIMENSIONS	PRICE
MS99115-XJ	STANLEY Tower (Premium Shop In Shop) Box1	1077mm W 2175mm H 972mm D	149.81 \$
MS99116-XJ	STANLEY Tower (Premium Shop In Shop) Box2	1077mm W 2175mm H 972mm D	149.82 \$
MS99117-XJ	STANLEY Tower (Premium Shop In Shop) Box3	1077mm W 2175mm H 972mm D	149.82 \$
MS99118-XJ	STANLEY Tower (Premium Shop In Shop) Box4	1077mm W 2175mm H 972mm D	149.82 \$

LOW LEVEL GONDOLA

1000mm LOW LEVEL GONDOLA - PEGBOARD



1000mm LOW LEVEL GONDOLA - PEGBOARD

CODE	DESCRIPTION	DIMENSIONS	PRICE
STHT8-73715	1000mm Low Level Gondola - Pegboard	1029mm W 1459mm H 541mm D	138.47 \$

UNIVERSAL 0.5m FLOOR-STAND

UNIVERSAL 0.5m FLOOR-STAND

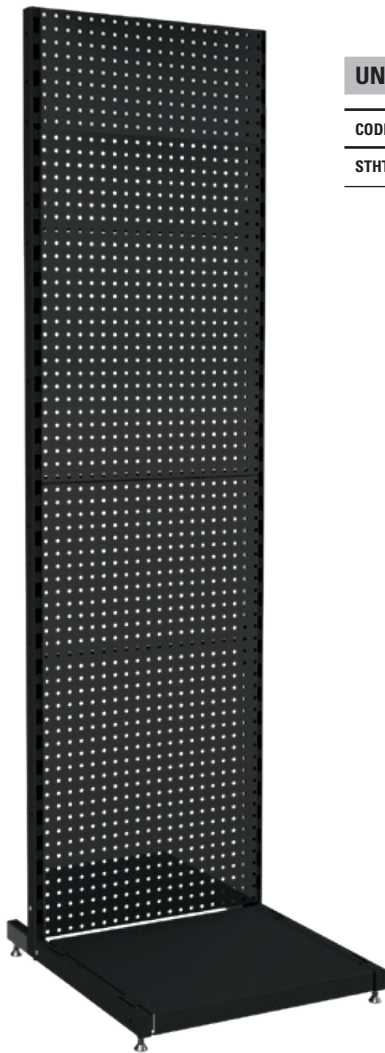

UNIVERSAL 0.5m FLOOR-STAND

CODE	DESCRIPTION	DIMENSIONS	PRICE
STHT8-73706	Universal 0.5m Floor-Stand	525mm W 1878mm H 591mm D	85.75 \$

MAIN UNIT EXAMPLE

Modular header not included



STANLEY MODULAR HEADER



STANLEY MODULAR HEADER

CODE	DESCRIPTION	DIMENSIONS	PRICE
STHT8-73707	STANLEY Modular Header	528mm W 150mm H 149mm D	7.13 \$

DEMO FSU

STANLEY DEMO FSU - DRYWALL



STANLEY DEMO FSU (DRYWALL)

CODE	DESCRIPTION	DIMENSIONS	PRICE
MS99215-XJ	STANLEY Demo FSU (Drywall)	425mm W 1877mm H 591mm D	136.56 \$

STEEL BASKETS DISPLAY

STANLEY STEEL BASKETS DISPLAY

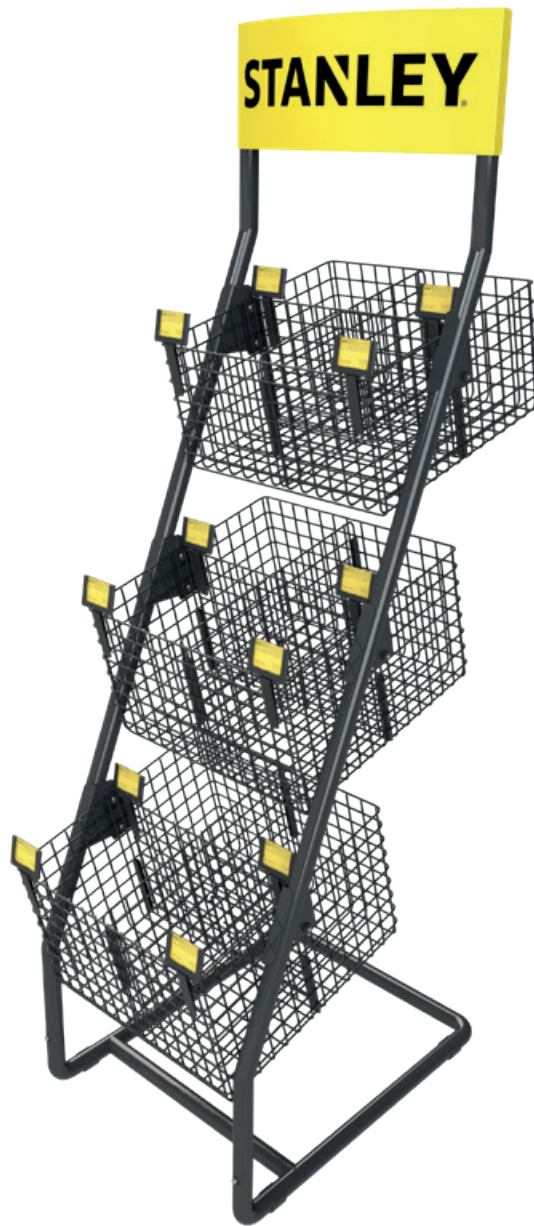

POS graphics supplied
separately

STANLEY STEEL BASKETS DISPLAY

CODE	DESCRIPTION	DIMENSIONS	PRICE
MS99217-XJ	STANLEY Steel Baskets Display	400mm W 1433mm H 525mm D	83.00 \$

STANLEY FSU ROTATOR

STANLEY FSU ROTATOR

- Includes 60x 150mm single prong hooks.
- Display comes with 3X Stanley header graphics.

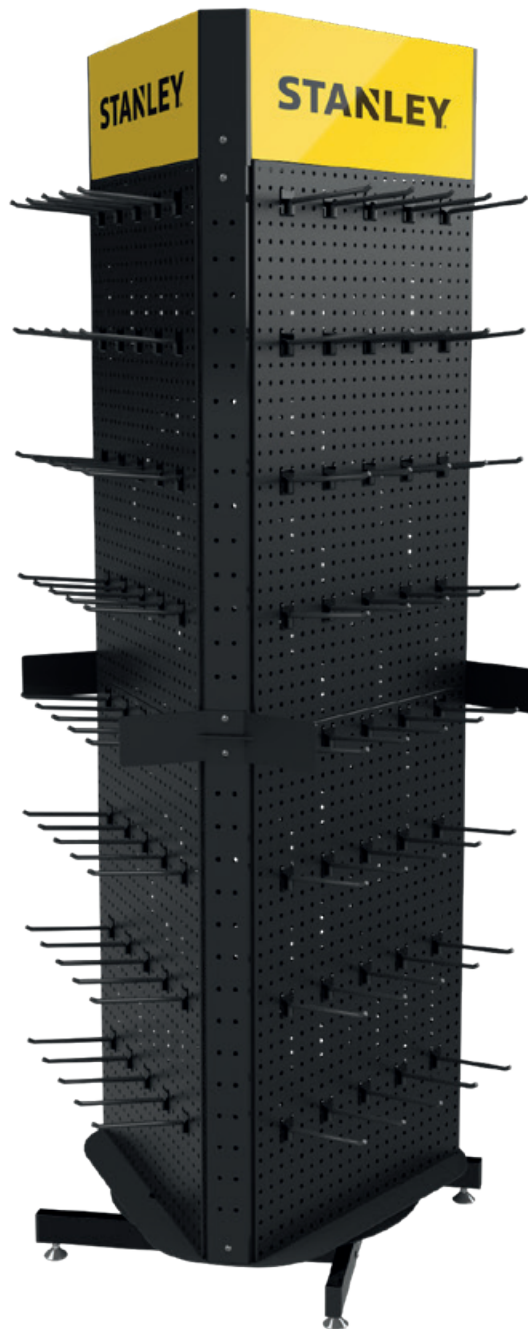

STANLEY FSU ROTATOR

CODE	DESCRIPTION	DIMENSIONS	PRICE
MS99898-XJ	STANLEY ROTATOR (BOX 1 OF 2) (NON-LINGUAL)	550mm W 1928mm H 550mm D	136.48 \$
MS99899-XJ	STANLEY ROTATOR (BOX 2 OF 2) (NON-LINGUAL)	550mm W 1928mm H 550mm D	136.48 \$

FOLDING WORKBENCH DISPLAY

STANLEY FOLDING WORKBENCH DISPLAY



- Non -lingual graphics included

STANLEY FOLDING WORKBENCH DISPLAY

CODE	DESCRIPTION	DIMENSIONS	PRICE
MS99190-XJ	STANLEY Folding Workbench Display	900mm W 620mm H 520mm D	57.50 \$

WORKBENCH ADD-ON

STANLEY SAW ADD-ON



Generic header and front graphic included

STANLEY SAW ADD-ON

CODE	DESCRIPTION	DIMENSIONS	PRICE
MS99193-XJ	STANLEY Saw Add-On	200mm W 666mm H 505mm D	51.75 \$

STANLEY TRIGGER CLAMP ADD-ON

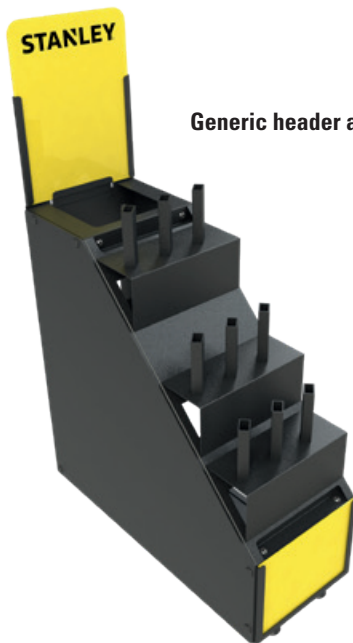

Generic header and front graphic included

STANLEY TRIGGER CLAMP ADD-ON

CODE	DESCRIPTION	DIMENSIONS	PRICE
MS99192-XJ	STANLEY Trigger Clamp Add-On	200mm W 666mm H 505mm D	57.25 \$

MAIN UNIT EXAMPLE

ORDER QTY	ITEM
1	Folding Workbench Display
1	Saw Add-On
1	Trigger Clamp Add-On

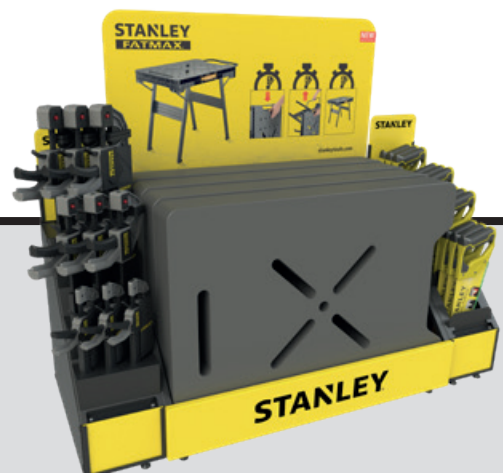

TOUGH SYSTEM DISPLAY

STANLEY FATMAX TOUGH SYSTEM DISPLAY



MAIN UNIT EXAMPLE



STANLEY FATMAX TOUGH SYSTEM DISPLAY

CODE	DESCRIPTION	DIMENSIONS	PRICE
MS99329-XJ	STANLEY FATMAX Tough System Display	900mm W 620mm H 520mm D	57.50 \$

12" HD SCREEN WITH CASE AND BRACKET FOR SFM TOUGH SYSTEM DISPLAY



12" HD SCREEN WITH CASE AND BRACKET

CODE	DESCRIPTION	DIMENSIONS	PRICE
MS99367-XJ	12" HD Screen with case and bracket for SFM Tough System Display	mm W 235mm H 30mm D	99.85 \$

PROSTAK DISPLAY

STANLEY FATMAX PROSTAK DISPLAY



Screen has separate SKU



STANLEY FATMAX PROSTAK DISPLAY

CODE	DESCRIPTION	DIMENSIONS	PRICE
MS99328-XJ	STANLEY FATMAX PROSTAK Display	692mm W 1907mm H 482mm D	97.00 \$

12" HD SCREEN WITH CASE AND BRACKET FOR SFM TSTAK DISPLAY

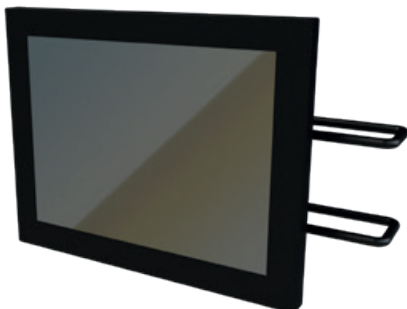

12" HD SCREEN WITH CASE AND BRACKET FOR SFM TSTAK DISPLAY

CODE	DESCRIPTION	DIMENSIONS	PRICE
MS99366-XJ	12" HD Screen with case and bracket for SFM TSTAK Display	- mm W 235mm H - mm D	100.80 \$

PROSTAK DISPLAY

STANLEY FATMAX PROSTAK 0.5m FSU



STANLEY FATMAX PROSTAK 0.5m FSU

CODE	DESCRIPTION	DIMENSIONS	PRICE
MS99790-XJ	STANLEY FATMAX PROSTAK 0.5m FSU	537mm W 1880mm H 590mm D	148.00 \$

SAW RACK HOLDER



SAW RACK HOLDER

CODE	DESCRIPTION	DIMENSIONS	PRICE
MS99805-XJ	Saw Rack Holder (Non-Lingual) Box 1	400mm W 1393mm H 390mm D	65.00 \$
MS99806-XJ	Saw Rack Holder (Non-Lingual) Box 2	400mm W 1393mm H 390mm D	00.00 \$

PALLET HIGHLIGHTER

PALLET HIGHLIGHTER DISPLAY

- Supplied with a pair of Universal Tool Holders
- Artwork must be ordered separately

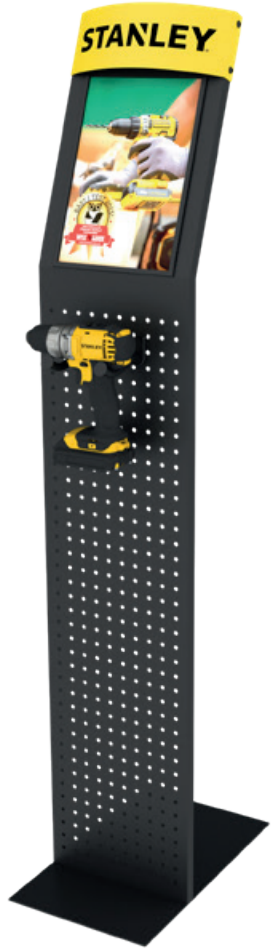

PALLET HIGHLIGHTER DISPLAY

CODE	DESCRIPTION	DIMENSIONS	PRICE
-	STANLEY Pallet Highlighter Display	270mm W 1450mm H 270mm D	58.00 \$

PALLET HIGHLIGHTER DISPLAY WITH 12" SCREEN

- Supplied with a pair of Universal Tool Holders
- Supplied with 12" HD Screen

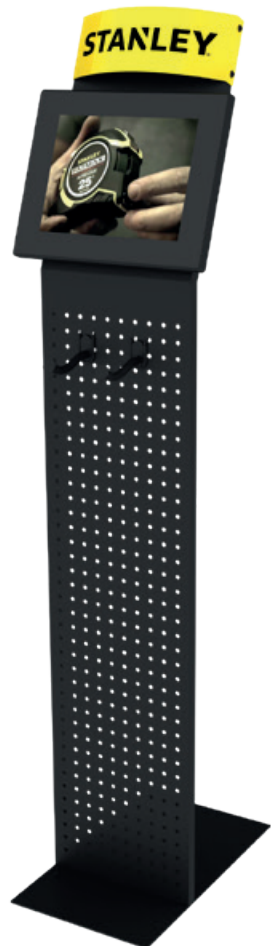

STANLEY PALLET HIGHLIGHTER WITH 12" SCREEN

CODE	DESCRIPTION	DIMENSIONS	PRICE
MS99216-XJ	STANLEY Pallet Highlighter with 12" Screen	337mm W 1450mm H - 450mm D	155.00 \$



COUNTER TOP

TURN MEASUREMENTS INTO SPACES
TLM 99 LASER DISTANCE MEASURER
 • 165' (50m) range
 • Bluetooth® connectivity
 • Auto-off feature
 • LCD display
 • 1/16" resolution

GET CONNECTED FOR SMARTER WORKING
TLM 600 LASER DISTANCE MEASURER
 • 656' (200m) range
 • Bluetooth® connectivity
 • Auto-off feature
 • LCD display
 • 1/16" resolution

TURN MEASUREMENTS INTO SPACES
TLM 99 LASER DISTANCE MEASURER
 • 165' (50m) range
 • Bluetooth® connectivity
 • Auto-off feature
 • LCD display
 • 1/16" resolution

STANLEY

WALLS, FLOORS AND CEILINGS COVERED
X13 MULTI-LINE LASER LEVEL
 With 3 energy-saving projecting 4 green cross beams automatically, the X13 lets every job you need for the accurate marking for the walls, with and without.
 Is brighter than traditional red lasers for ultimate visibility, even in bright conditions.
 • Project 4 cross lines simultaneously
 • Working Area: 100'
 • Working Distance: 200'
 • Easy mode for use with auto-on auto-off
 • Tough and rugged for your toughest working conditions
 stanleytools.com

STANLEY TLM 99
 Laser Distance Measurer
 165' (50m) Range
 Bluetooth® Connectivity

STANLEY TLM 99
 Laser Distance Measurer
 165' (50m) Range
 Bluetooth® Connectivity

STANLEY TLM 99
 Laser Distance Measurer
 165' (50m) Range
 Bluetooth® Connectivity

STANLEY TLM 99
 Laser Distance Measurer
 165' (50m) Range
 Bluetooth® Connectivity

STANLEY

www.stanleytools.com

COUNTER TOP UNITS

SMALL COUNTER UNIT



SMALL COUNTER UNIT

CODE	DESCRIPTION	DIMENSIONS	PRICE
MS99048-XJ	Small Counter Unit	423mm W 761mm H 302mm D	36.86 \$

MULTI MECHANICS TOOLS (NON-LINGUAL)



MULTI MECHANICS TOOLS (NON-LINGUAL)

CODE	DESCRIPTION	DIMENSIONS	PRICE
MS99817-XJ	Multi Mechanics Tools (Non-Lingual)	656mm W 442mm H 130mm D	39.00 \$

MINI ROTATING CTU



MINI ROTATING CTU

CODE	DESCRIPTION	DIMENSIONS	PRICE
MS99047-XJ	Mini Rotating CTU	250mm W 500mm H 250mm D	48.29 \$

STANLEY GP SAW MERCHANDISER

STANLEY GP SAW MERCHANDISER



MAIN UNIT EXAMPLE



- Front and top graphic not included

SAW DISPLAY

CODE	DESCRIPTION	DIMENSIONS	PRICE
MS99082-XJ	Saw Display	170mm W 686mm H - 475mm D	43.17 S

COUNTER TOP UNITS

STANLEY HERO PLINTH CTU WITH 7" SCREEN



STANLEY HERO PLINTH CTU WITH 7" SCREEN

CODE	DESCRIPTION	DIMENSIONS	PRICE
MS99453-XJ	STANLEY Hero Plinth CTU with 7" Screen	270mm W 458mm H 252mm D	115.00 \$

LASER HOOK MODULE



- Supplied with 1x 200mm clamp hook with POS holder.
- Graphics supplied separately



STANLEY LASER HOOK MODULE

CODE	DESCRIPTION	DIMENSIONS	PRICE
MS99307-XJ	STANLEY Laser Hook Module	270mm W 458mm H 245mm D	20.00 \$

LASER PRODUCT MODULE



- Graphics supplied separately



STANLEY LASER PRODUCT MODULE

CODE	DESCRIPTION	DIMENSIONS	PRICE
MS99308-XJ	STANLEY Laser Product Module	270mm W 458mm H 245mm D	20.00 \$

COUNTER TOP UNITS

CARBIDE CTU

- Includes 4x 150mm Eurohooks
- Excludes graphic and header



CARBIDE CTU

CODE	DESCRIPTION	DIMENSIONS	PRICE
MS99049-XJ	Carbide CTU	237mm W 484mm H - 285mm D	32.01 \$

RATCHET SET CTU



RATCHET SET CTU

CODE	DESCRIPTION	DIMENSIONS	PRICE
MS99816-XJ	0.5 Ratchet Set CTU (Non-Lingual)	437mm W 340mm H - 900mm D	24.00 \$

STANLEY FATMAX COUNTER TOP UNITS

STANLEY FATMAX POWERBLAST CTU



STANLEY FATMAX POWERBLAST CTU

CODE	DESCRIPTION	DIMENSIONS	PRICE
MS99870-XJ	STANLEY FATMAX Powerblast CTU	300mm W 450mm H 120mm D	27.00 \$

STANLEY FATMAX FLEXIBLE CTU

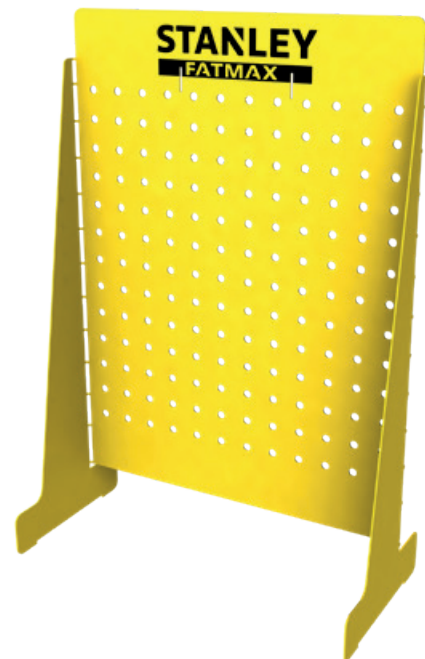

STANLEY FATMAX FLEXIBLE CTU

CODE	DESCRIPTION	DIMENSIONS	PRICE
MS99871-XJ	STANLEY FATMAX Flexible CTU	310mm W 465mm H 155mm D	15.00 \$

STANLEY COUNTER TOP UNITS

STANLEY POWERBLAST CTU



STANLEY POWERBLAST CTU

CODE	DESCRIPTION	DIMENSIONS	PRICE
MS99872-XJ	STANLEY Powerblast CTU	300mm W 450mm H 120mm D	27.00 \$

STANLEY FLEXIBLE CTU

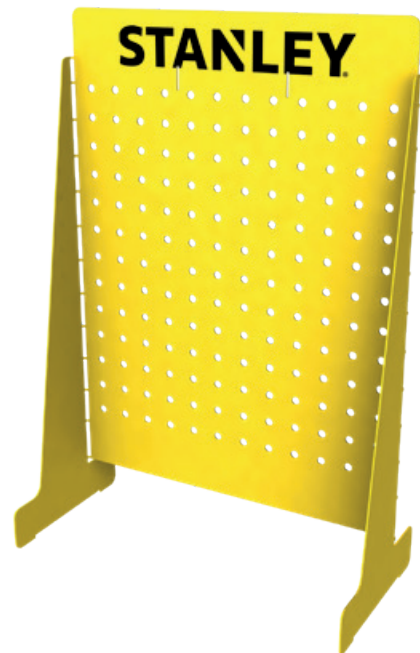

STANLEY FLEXIBLE CTU

CODE	DESCRIPTION	DIMENSIONS	PRICE
MS99873-XJ	STANLEY Flexible CTU	310mm W 465mm H 155mm D	15.00 \$

SPECIALIST DISPLAYS



ROTARY AND CROSSHAIR LASER CABINET

ROTARY AND CROSSHAIR LASER CABINET

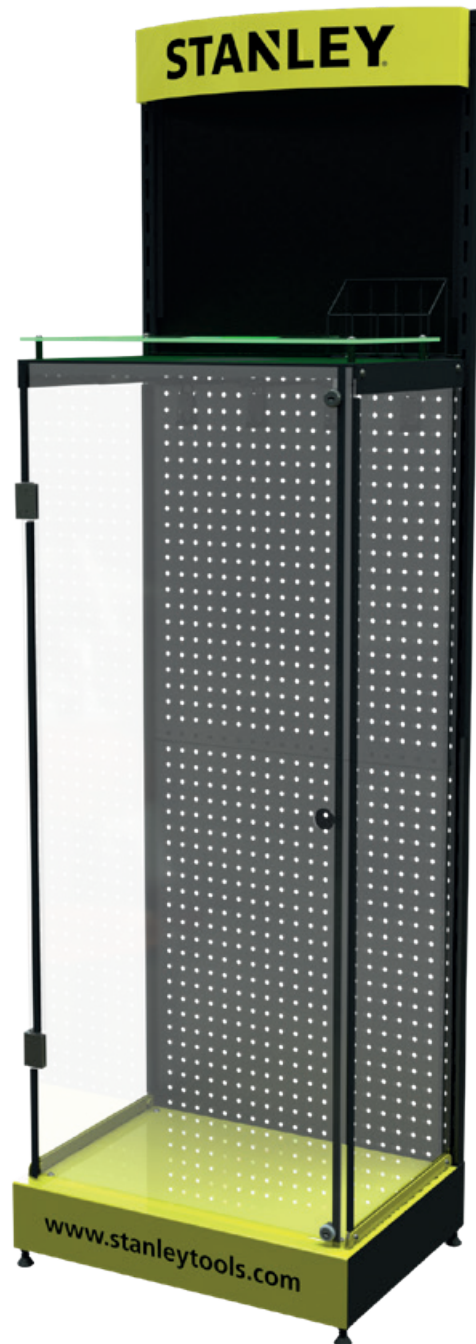

ROTARY AND CROSSHAIR LASER CABINET

CODE	DESCRIPTION	DIMENSIONS	PRICE
MS99006-XJ	Rotary and Crosshair Laser Cabinet	545mm W 1801mm H 397mm D	300.70 S

ROTARY LASER CABINET ASSEMBLY

ROTARY LASER CABINET ASSEMBLY

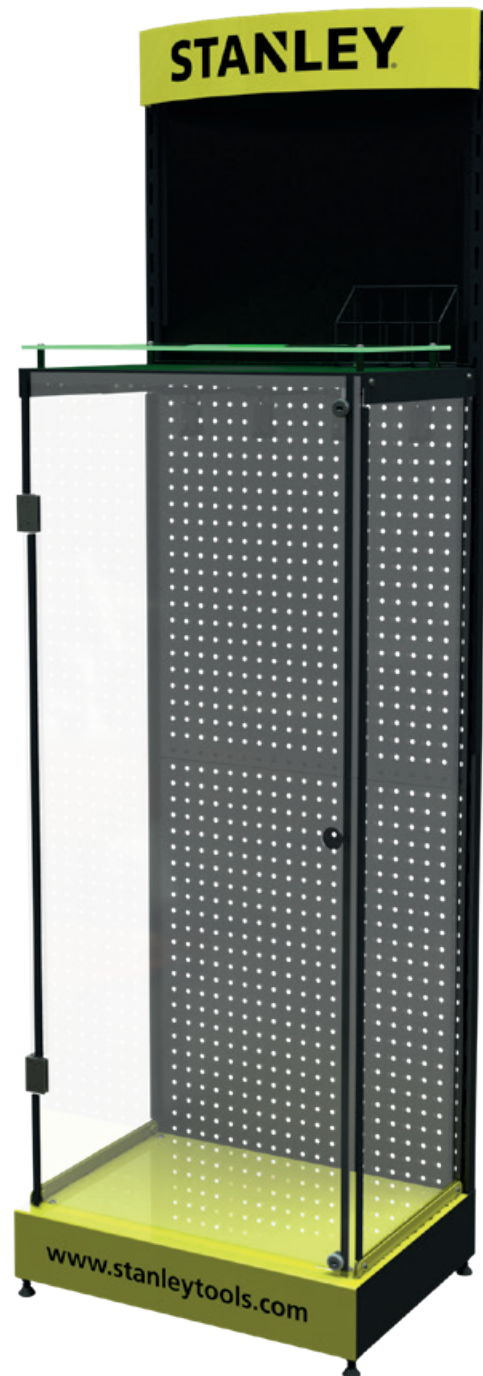

ROTARY LASER CABINET ASSEMBLY

CODE	DESCRIPTION	DIMENSIONS	PRICE
MS99005-XJ	Rotary Laser Cabinet Assembly	545mm W 1801mm H 397mm D	300.70 \$

GREEN BEAM CROSSHAIR LASER UNIT

GREEN BEAM CROSSHAIR LASER UNIT

- Display supplied with 6X 300mm Clamp Hooks

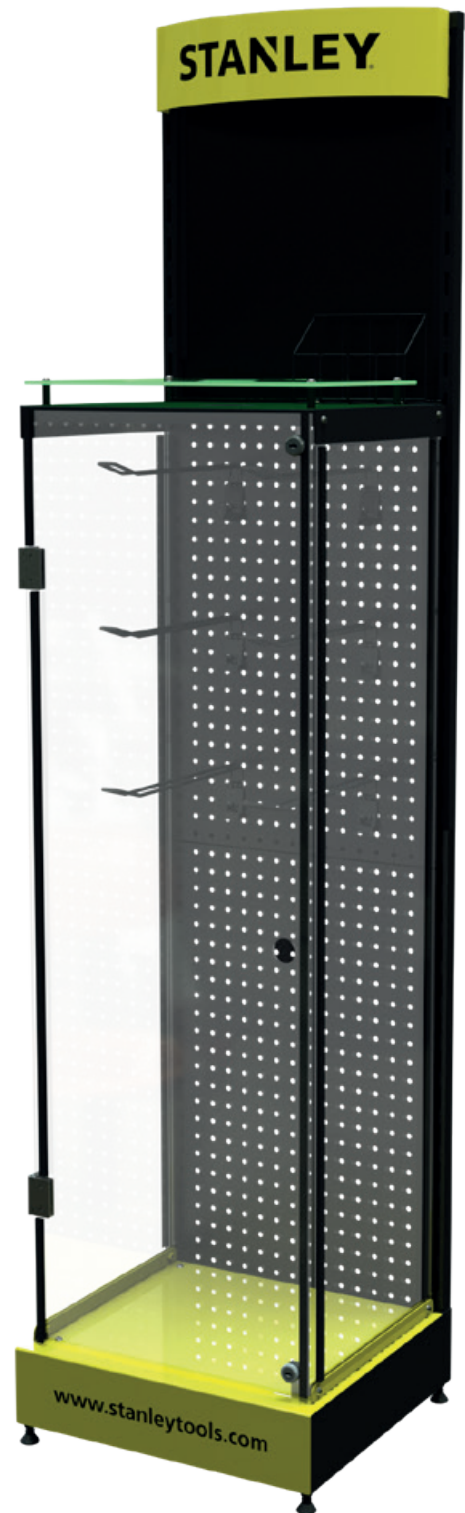
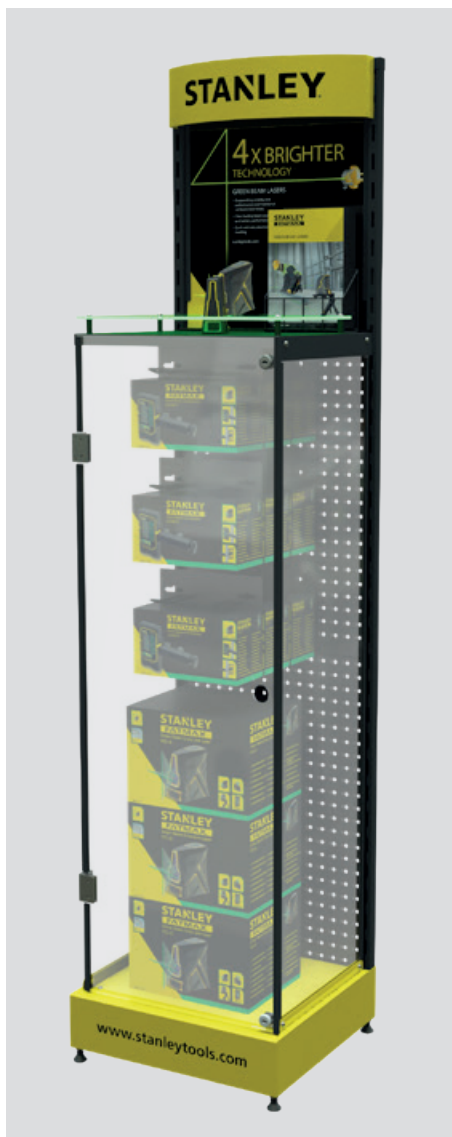

GREEN BEAM CROSSHAIR LASER UNIT

CODE	DESCRIPTION	DIMENSIONS	PRICE
MS99004-XJ	Green Beam Crosshair Laser Unit	428mm W 1801mm H 397mm D	237.65 \$

LASER CABINET

LASER LOCKABLE CABINET

LASER LOCKABLE CABINET

CODE	DESCRIPTION	DIMENSIONS	PRICE
STHT6-97886	Laser Lockable Cabinet	428mm W 1701mm H 369mm D	213.40 \$

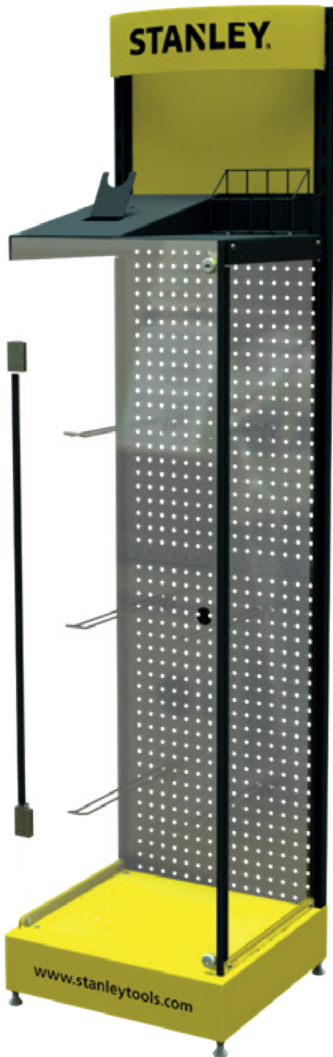

- Display includes lockable cabinet for valuable merchandise.
- Prominent positioned demo area with adjacent leaflet holder.
- Interchangeable graphic panel located below branded header.



LARGE LASER CABINET



LARGE LASER CABINET

CODE	DESCRIPTION	DIMENSIONS	PRICE
MS99093-XJ	Large Laser Cabinet	545mm W 1801mm H 397mm D	281.30 \$

HALF PALLET CABINET DISPLAY

HALF PALLET CABINET DISPLAY

- 2X Long Display Plinth
- 12X A6 POS Holders
- 12X Acrylic Laser Tool Holder



HALF PALLET CABINET DISPLAY

CODE	DESCRIPTION	DIMENSIONS	PRICE
MS99259-XJ	Half Pallet Cabinet Display	644mm W 1498mm H 800mm D	442.00 \$

EHT LASER SPECIALIST CENTRE HALF PALLET (NON-LINGUAL)

- 2X Long Display Plinths
- 8X A6 POS Holders
- 3X Acrylic Laser Tool Holder

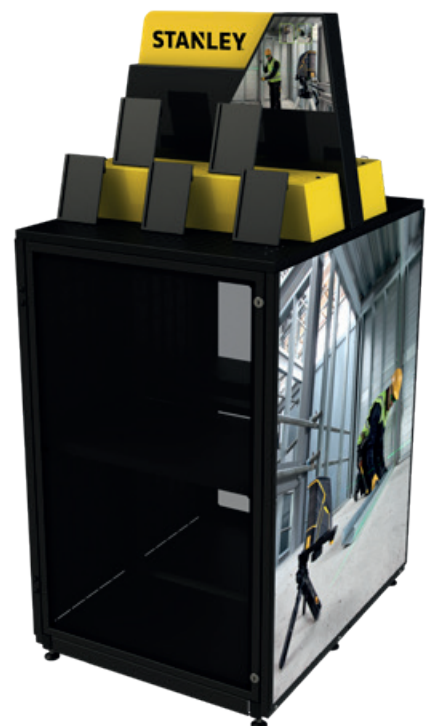

EHT LASER SPECIALIST CENTRE HALF PALLET (NON-LINGUAL)

CODE	DESCRIPTION	DIMENSIONS	PRICE
MS99579-XJ	EHT Laser Specialist Centre Half Pallet (Non-Lingual)	644mm W 1498mm H 800mm D	425.00 \$

SECURE CABINET

LASER SECURE CABINET

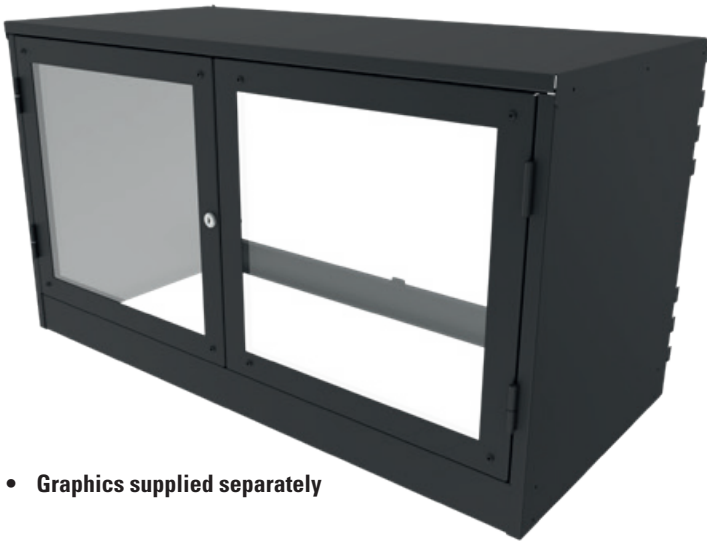

- Graphics supplied separately



LASER SECURE CABINET

CODE	DESCRIPTION	DIMENSIONS	PRICE
MS99316-XJ	Laser Secure Cabinet	998mm W 558mm H 495mm D	138.50 \$

LOCKABLE CABINET WITH BATTERY HOLES (NON-LINGUAL)



LOCKABLE CABINET WITH BATTERY HOLES (NON-LINGUAL)

CODE	DESCRIPTION	DIMENSIONS	PRICE
MS99340-XJ	Lockable Cabinet With Battery Holes (Non-Lingual)	997mm W 558mm H - 496mm D	142.50 \$

ELECTRONIC HAND TOOL CABINET DISPLAY

ELECTRONIC HAND TOOL CABINET DISPLAY 2

- 2X Long Plinth Fabrication
- 16X A6 POS Holders
- 7X Acrylic Laser Tool Holders
- 1X Thermometer Gun Tool Holder
- 1X Inspection Camera Tool Holder



ELECTRONIC HAND TOOL CABINET DISPLAY 2

CODE	DESCRIPTION	DIMENSIONS	PRICE
MS99260-XJ	Electronic Hand Tool Cabinet Display 2	1232mm W 1548mm H 798mm D	630.00 \$

FRENCH CABINET DISPLAY WITH SIDE BAR

- 1X 7" HD Screen
- 2X Long Plinth Fabrication
- 14X A6 POS Holders
- 6X Acrylic Laser Tool Holders
- 1X Thermometer Gun Tool Holder
- 1X Inspection Camera Tool Holder
- 1X A4 Leaflet Holder



FRENCH CABINET DISPLAY WITH SIDE BAR

CODE	DESCRIPTION	DIMENSIONS	PRICE
MS99333-XJ	French Cabinet Display with Side Bar	1580mm W 1543mm H 802mm D	764.00 \$

EHT LASER SPECIALIST CENTRE FULL PALLET (NON-LINGUAL)



- 2X Long plinth fabrication
- 15X A6 POS Holders
- 4X Acrylic Laser Tool Holders
- 1X Thermometer Gun Tool Holder
- 1X Inspection Camera Tool Holder

EHT LASER SPECIALIST CENTRE FULL PALLET (NON-LINGUAL)

CODE	DESCRIPTION	DIMENSIONS	PRICE
MS99580-XJ	EHT Laser Specialist Centre Full Pallet (Non-Lingual)	1232mm W 1548mm H 798mm D	586.00 \$

EHTL CABINET DISPLAY 1 (INCLUDES 7" SCREEN)

- 1X 7" HD Screen
- 2X Long Display Plinth Fabrication
- 15X A6 POS Holders
- 7X Acrylic Laser Tool Holders
- 1X A4 Leaflet Holder
- 1X Thermometer Gun Tool Holder
- 1X Inspection Camera Tool Holder



EHTL CABINET DISPLAY 1 (INCLUDES 7" SCREEN)

CODE	DESCRIPTION	DIMENSIONS	PRICE
MS99257-XJ	EHT Cabinet Display 1 (Includes 7" Screen)	1232mm W 1548mm H - 798mm D	752.00 \$

ACRYLIC TOOL HOLDER

ACRYLIC TOOL HOLDER

CODE	DESCRIPTION	DIMENSIONS	PRICE
MS99334-XJ	Acrylic Tool Holder (pack of 6)	70mm W 113mm H - 63mm D	6.50 \$



PODIUM DISPLAY

TRIPLE PODIUM LASER DISPLAY

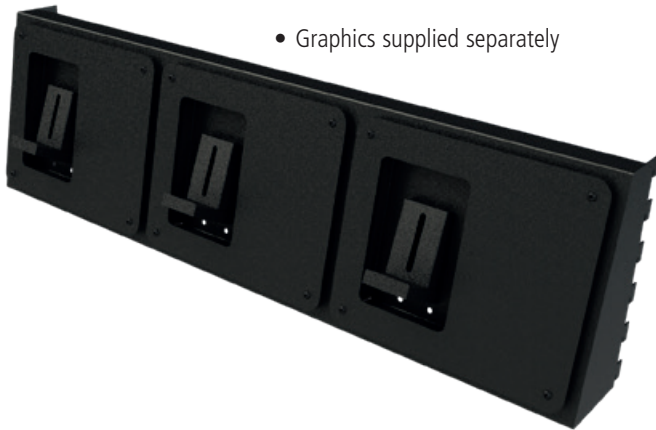

- Graphics supplied separately



TRIPLE PODIUM LASER DISPLAY

CODE	DESCRIPTION	DIMENSIONS	PRICE
MS99261-XJ	Triple Podium Laser Display	998mm W 280mm H 123mm D	104.00 \$

POWER TOOLS TRIPLE PODIUM DISPLAY

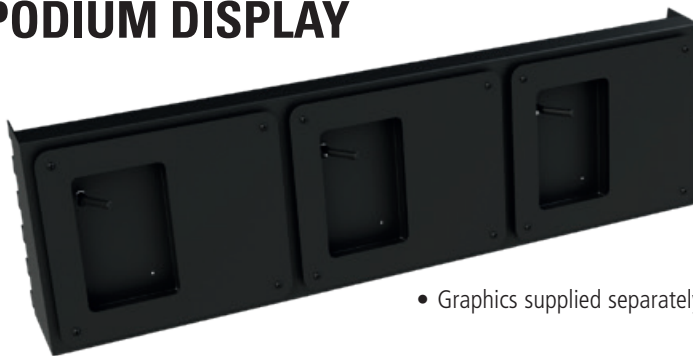

- Graphics supplied separately



POWER TOOLS TRIPLE PODIUM DISPLAY

CODE	DESCRIPTION	DIMENSIONS	PRICE
MS99339-XJ	Power Tools Triple Podium Display	998mm W 280mm H 123mm D	72.50 \$

SINGLE LASER PODIUM/CTU

SINGLE LASER PODIUM/CTU

CODE	DESCRIPTION	DIMENSIONS	PRICE
MS99317-XJ	Single Laser Podium/CTU	338mm W 338mm H 157mm D	32.00 \$



STANLEY PLINTHS

STANLEY ILLUMINATED PLINTH

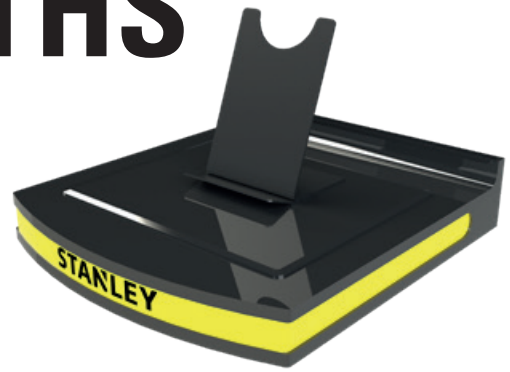

STANLEY ILLUMINATED PLINTH

CODE	DESCRIPTION	DIMENSIONS	PRICE
MS99051-XJ	STANLEY Illuminated Plinth	200mm W 129mm H 220mm D	26.68 \$

- Graphics supplied separately



STANLEY ILLUMINATED PLINTH BRACKET

CODE	DESCRIPTION	DIMENSIONS	PRICE
MS99054-XJ	STANLEY Illuminated Plinth Bracket	135mm W 40mm H 160mm D	2.43 \$

STANLEY PLINTH



STANLEY DRILL PLINTH

CODE	DESCRIPTION	DIMENSIONS	PRICE
MS99761-XJ	STANLEY Drill Plinth	204mm W 275mm H - 311mm D	12.50 \$

TOP SELLER SCREWDRIVER TRAY & POS STRIP

TOP SELLER SCREWDRIVER TRAY & POS STRIP



TOP SELLER SCREWDRIVER TRAY + POS STRIP

CODE	DESCRIPTION	DIMENSIONS	PRICE
FMHT7-97283	Top Seller Screwdriver Tray + POS Strip	998.4mm W 129.2mm H 350mm D	76.44 \$

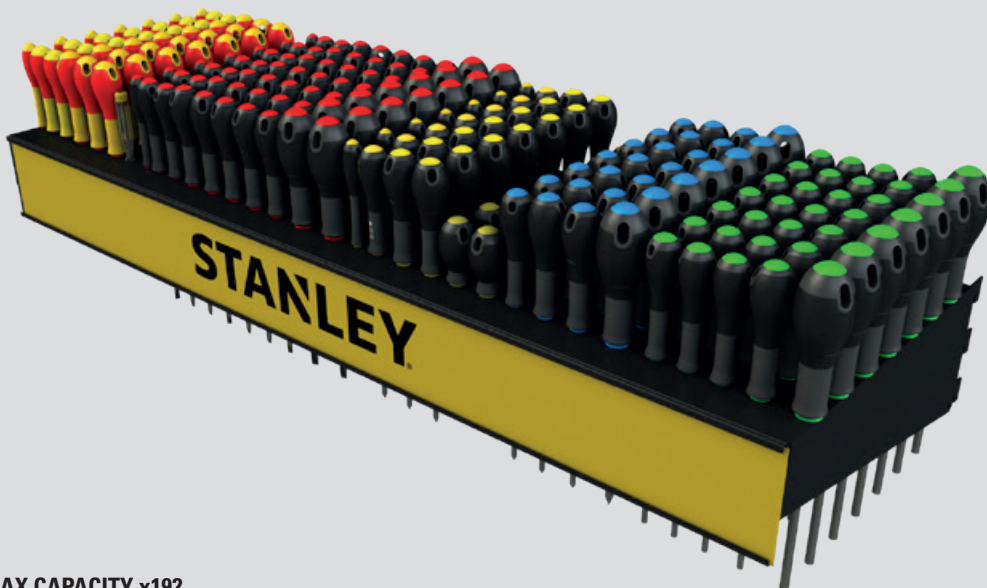

SCREWDRIVER MAX CAPACITY x192

SCREWDRIVER CTU

SCREWDRIVER CTU

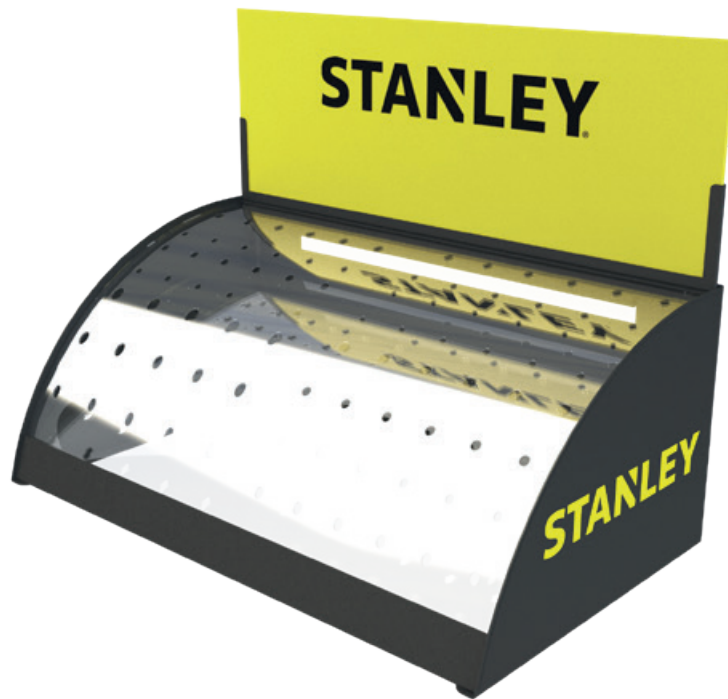

SCREWDRIVER CTU

CODE	DESCRIPTION	DIMENSIONS	PRICE
FMHT7-97284	Screwdriver CTU	510mm W 393mm H 295mm D	53.93 \$

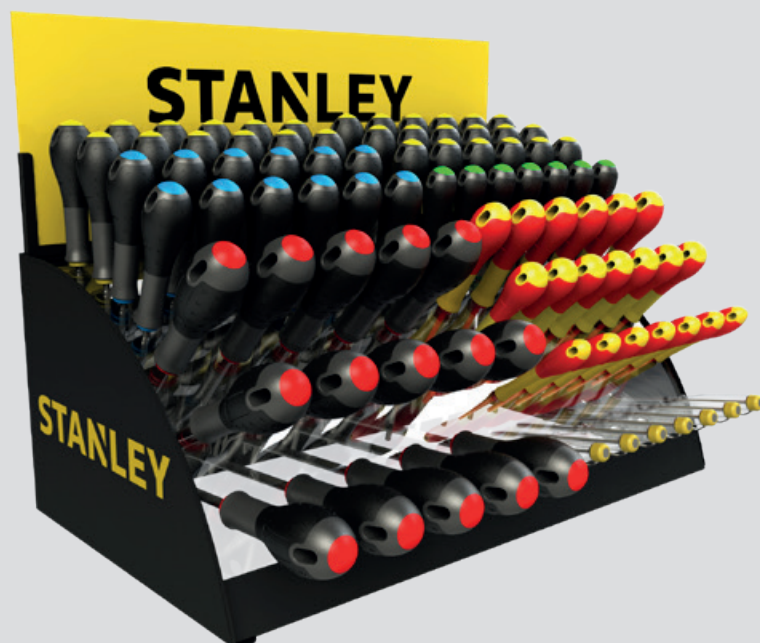

SCREWDRIVER MAX CAPACITY x87

SPIRIT LEVEL DISPLAY

COMPACT FLOOR-STANDING DISPLAY FOR SPIRIT LEVELS



STANLEY CLASSIC PRO LEVELS A5 LEAFLET HOLDER

CODE	DESCRIPTION	DIMENSIONS	PRICE
MS99670-XJ	STANLEY Classic Pro Levels A5 Leaflet Holder	150mm W 212mm H 183mm D	9.00 \$

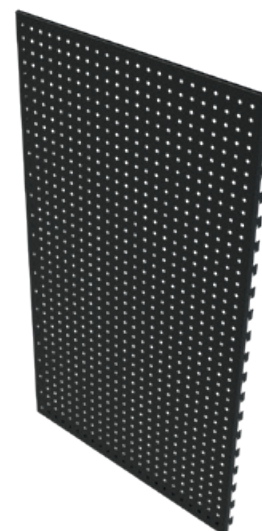

HALF PALLET CABINET DISPLAY

CODE	DESCRIPTION	DIMENSIONS	PRICE
MS99598-XJ	STANLEY Levels FSDU	630mm W 1897mm H 494mm D	187.00 \$

STANLEY CLASSIC PRO LEVELS PEGBOARD ADD-ON

CODE	DESCRIPTION	DIMENSIONS	PRICE
MS99671-XJ	STANLEY Classic Pro Levels Pegboard Add-On	590mm W 1025mm H 30mm D	23.00 \$

DRILL HOLDER

LASER SECURE CABINET

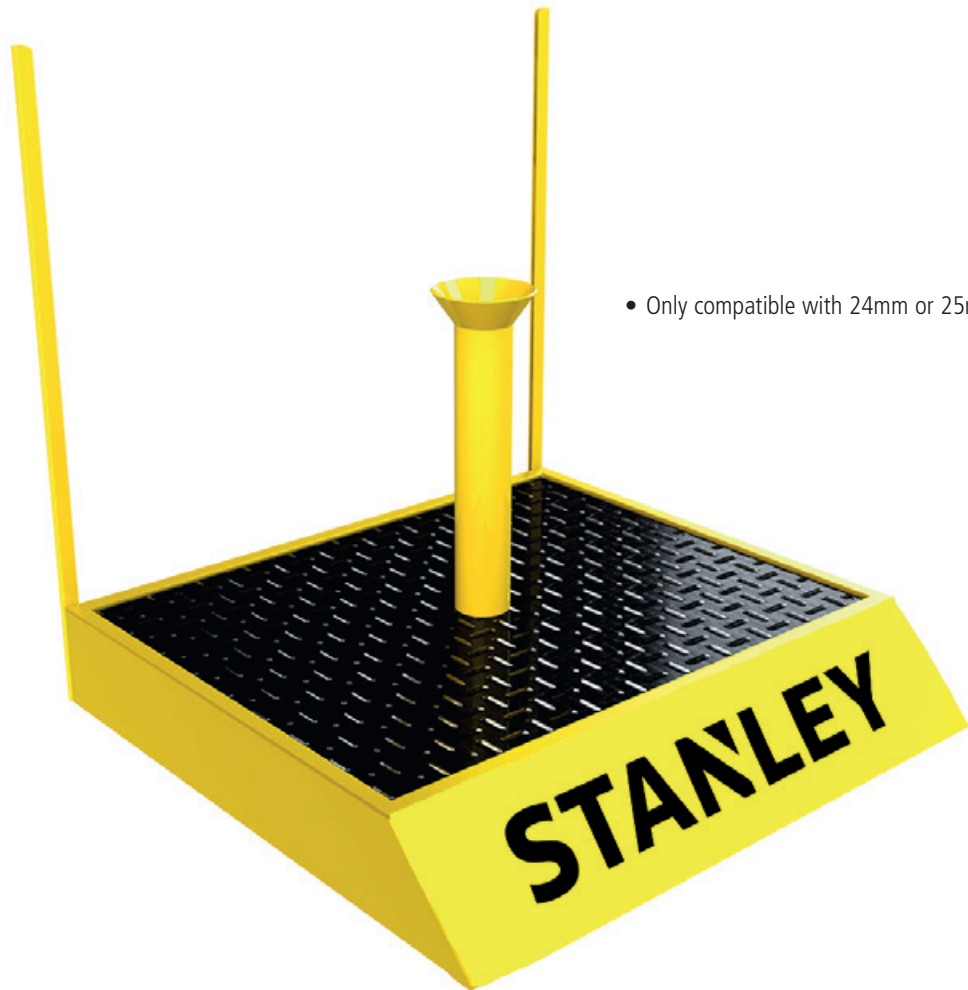

- Only compatible with 24mm or 25mm drill bits

STANLEY FATMAX DRILL HOLDER

CODE	DESCRIPTION	DIMENSIONS	PRICE
MS99745-QZ	STANLEY FATMAX Drill Holder	502mm W 501mm H - 497mm D	26.19 \$

SPIRIT LEVEL DISPLAY

COMPACT FLOOR-STANDING DISPLAY FOR SPIRIT LEVELS



COMPACT FLOOR-STANDING DISPLAY FOR SPIRIT LEVELS

CODE	DESCRIPTION	DIMENSIONS	PRICE
STHT8-73708	Compact Floor-Standing Display for Spirit Levels	383mm W 460mm H 261mm D	33.17 \$

200mm STANLEY TOWER

200MM STANLEY TOWER



- Compact floor-standing tower for impulse locations in-store.



STANLEY FATMAX DRILL HOLDER

CODE	DESCRIPTION	DIMENSIONS	PRICE
STHT6-97898	200mm STANLEY Tower	300mm W 1459mm H - 300mm D	46.08 \$

HOPPERS

STANLEY SQUARE HOPPER

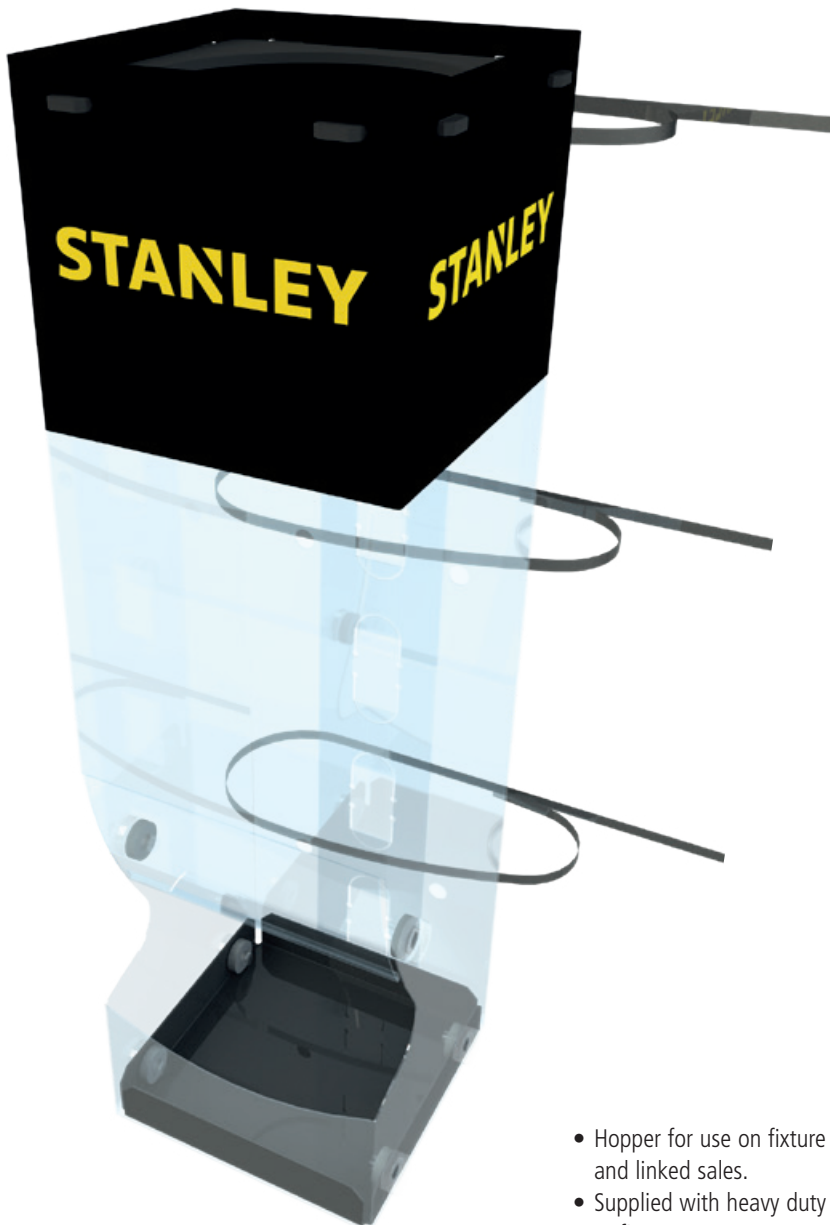

- Hopper for use on fixture or on shelf for impulse and linked sales.
- Supplied with heavy duty cable ties for attaching to fixtures.

STANLEY SQUARE HOPPER

CODE	DESCRIPTION	DIMENSIONS	PRICE
MS99491-XJ	STANLEY Square Hopper	115mm W 398mm H 115mm D	15.79 \$

200mm STANLEY ON FIXTURE HOPPER



- Hopper for use on fixture or on shelf for impulse and linked sales.
- Supplied with heavy duty cable ties for attaching to fixtures.

200MM STANLEY ON FIXTURE HOPPER			
CODE	DESCRIPTION	DIMENSIONS	PRICE
STHT6-97934	200mm STANLEY On Fixture Hopper	200mm W 521mm H - 249mm D	30.56 \$

STANLEY MINI HOPPER



STANLEY FATMAX DRILL HOLDER			
CODE	DESCRIPTION	DIMENSIONS	PRICE
TBC	STANLEY Mini Hopper	176mm W 400mm H - 176mm D	12.13 \$

CLIP STRIP AND PARASITE UNIT

METAL CLIP STRIP



METAL CLIP STRIP (INCLUDES BRACKETS,CABLE TIES AND STICKERS)

CODE	DESCRIPTION	DIMENSIONS	PRICE
MA00733-OZ	Metal Clip Strip (Includes brackets, cable ties and stickers)	60mm W 900mm H 30mm D	3.88 \$

TAPE MEASURE PARASITE UNIT



TAPE MEASURE PARASITE UNIT

CODE	DESCRIPTION	DIMENSIONS	PRICE
MS99551-XJ	Tape Measure Parasite Unit	126mm W 955mm H 236mm D	60.00 \$

CATEGORY DISPLAY

STANLEY STAPLE GUN CATEGORY DISPLAY

- Non-lingual header graphic supplied



STANLEY STAPLE GUN CATEGORY DISPLAY

CODE	DESCRIPTION	DIMENSIONS	PRICE
MS99654-XJ	STANLEY Staple Gun category Display	995mm W 1100mm H - 247mm D	85.00 \$

LAWN & GARDEN VALANCE DISPLAY

LAWN & GARDEN VALANCE DISPLAY



COMPACT FLOOR-STANDING DISPLAY FOR SPIRIT LEVELS

CODE	DESCRIPTION	DIMENSIONS	PRICE
MS99756-XJ	Lawn & Garden Valance Display	1538mm W 1998mm H 1049mm D	256.12 \$

- Valance Display comes with V60 & V20 graphics.

MOWER DISPLAY

MOWER PODIUM DISPLAY

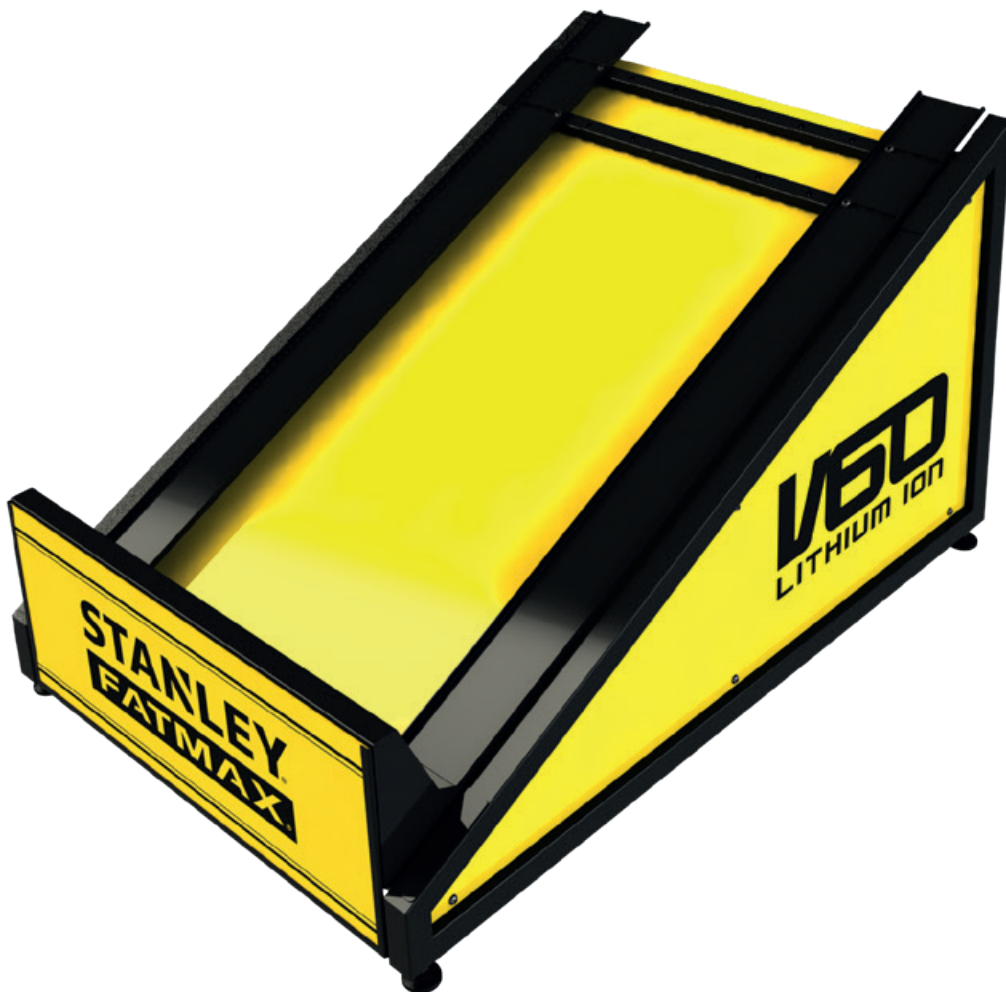

STANLEY FATMAX MOWER PODIUM DISPLAY

CODE	DESCRIPTION	DIMENSIONS	PRICE
MS99758-XJ	STANLEY FATMAX Mower Podium Display	635mm W 545mm H - 950mm D	100.00 \$

1m WRENCH DISPLAY

1M WRENCH DISPLAY HORIZONTAL

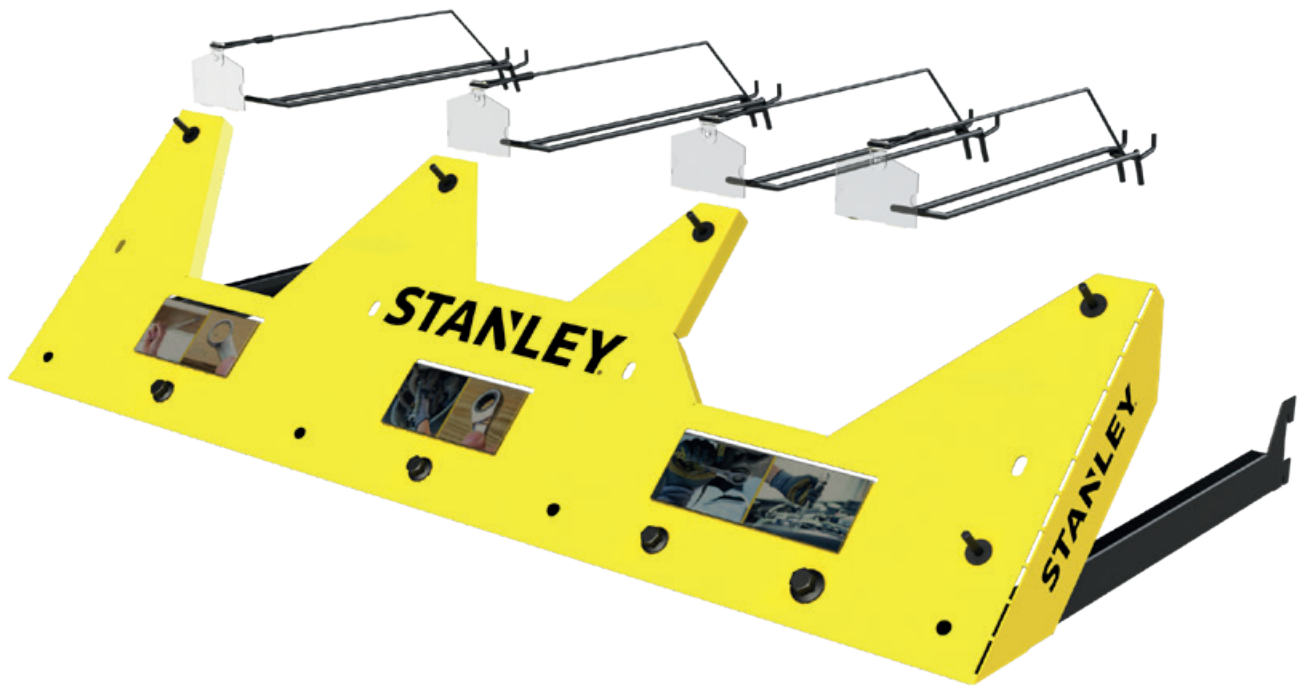

1M WRENCH HORIZONTAL (NON-LINGUAL)

CODE	DESCRIPTION	DIMENSIONS	PRICE
MS99822-XJ	1m Wrench Horizontal (Non-Lingual)	944mm W 213mm H 466mm D	47.50 \$

1M WRENCH DISPLAY VERTICAL



1M WRENCH VERTICAL (NON-LINGUAL)

CODE	DESCRIPTION	DIMENSIONS	PRICE
MS99823-XJ	1m Wrench Vertical (Non-Lingual)	392mm W 300mm H - 216mm D	38.00 \$

STANLEY FATMAX V20 DISPLAYS

STANLEY FATMAX V20 1M GONDOLA DISPLAY (+2 SHELVES)

- 20% more capacity on the pegboard
- New Style header that sits out from the unit to allow stock to be merchandised on the top of the pegboard
- Low profile base

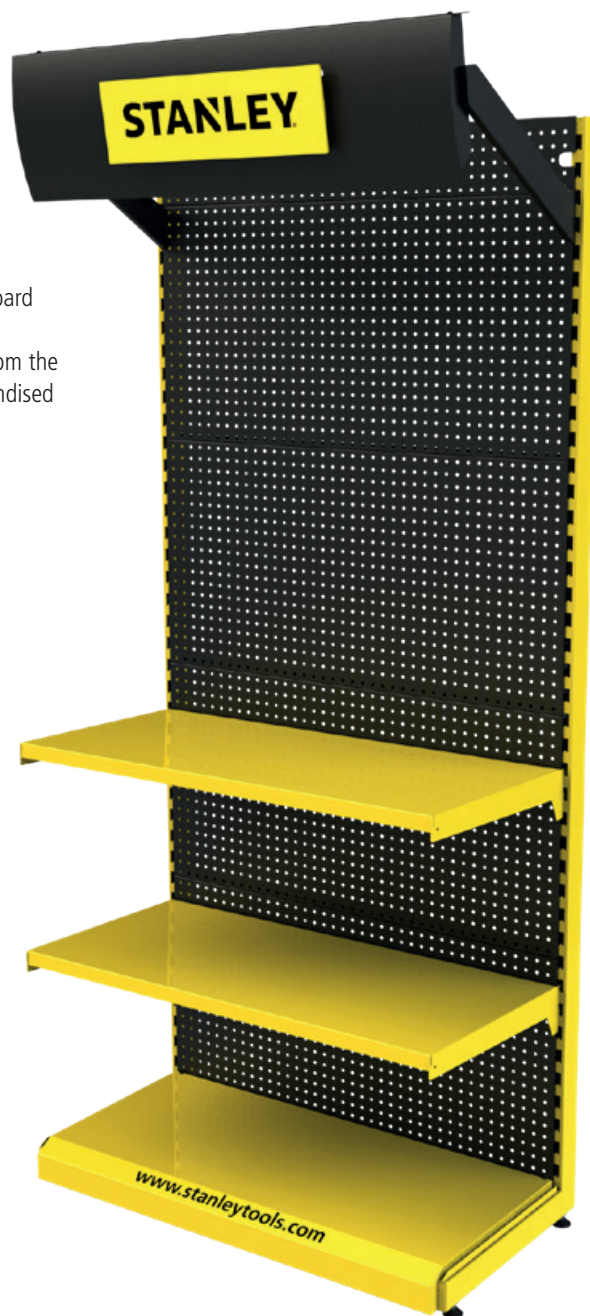

FATMAX V20 1M GONDOLA DISPLAY

CODE	DESCRIPTION	DIMENSIONS	PRICE
MS99836-FR	FATMAX V20 1m Gondola Display (+2 Shelves) Box 1	1030mm W 2256mm H 545mm D	274.00 \$
MS99837-FR	FATMAX V20 1m Gondola Display (+2 Shelves) Box 2	1030mm W 2256mm H 545mm D	0.00 \$

SFM V20 1M IN-FIXTURE ADD ON



SFM V20 1M IN-FIXTURE ADD ON

CODE	DESCRIPTION	DIMENSIONS	PRICE
MS99796-FR	SFM V20 1m In-Fixture Add On	996mm W 676mm H - 499mm D	147.00 \$

SFM V20 1.2M FSU (MINI IC)



SFM V20 1.2M FSU (MINI IC)

CODE	DESCRIPTION	DIMENSIONS	PRICE
MS99797-FR	SFM V20 1.2m FSU (Mini IC) Box 1	1269mm W 1498mm H - 513mm D	398.00 \$
MS99833-FR	SFM V20 1.2m FSU (Mini IC) Box 2	1269mm W 1498mm H - 513mm D	0.00 \$

COMPONENTS



STANLEY HEADERS

ILLUMINATED HEADER - REPLACEMENT INSERT



ILLUMINATED HEADER - REPLACEMENT INSERT

CODE	DESCRIPTION	DIMENSIONS	PRICE
STHT8-73698	Illuminated Header - Replacement Insert	645mm W 165mm H 233mm D	4.46 \$

1m ILLUMINATED HEADER - GLOBAL FORMAT



1M ILLUMINATED HEADER - GLOBAL FORMAT

CODE	DESCRIPTION	DIMENSIONS	PRICE
STHT8-73669	1m Illuminated Header - Global Format	995mm W 286mm H 233mm D	64.02 \$

NON ILLUMINATED HEADERS - GLOBAL FORMAT



NON ILLUMINATED HEADERS - GLOBAL FORMAT

CODE	DESCRIPTION	DIMENSIONS	PRICE
STHT8-73700	900mm Non Illuminated Header - Global Format	891mm W 286mm H 200mm D	32.95 \$
STHT8-73701	1m Non Illuminated Header - Global Format	995mm W 286mm H 233mm D	32.95 \$

SOFFITS & LAMPS

LED DOWN LIGHTING SOFFITS



• For use with Global Format

LED DOWN LIGHTING SOFFIT

CODE	DESCRIPTION	DIMENSIONS	PRICE
STHT8-73704	900mm LED Down Lighting Soffit - 3 Lamp	885mm W 24mm H - 175mm D	39.87 \$
STHT8-73703	1m LED Down Lighting Soffit - 4 Lamp	992mm W 36mm H - 207mm D	42.78 \$

REPLACEMENT PACK OF 4 LED LAMPS



REPLACEMENT PACK OF 4 LED LAMPS

CODE	DESCRIPTION	DIMENSIONS	PRICE
MP16822-GB	Replacement Pack of 4 LED Lamps	25mm W 25mm H - 10mm D	12.56 \$

DUAL HEADER KIT (NON-LINGUAL)



DUAL HEADER KIT (NON-LINGUAL)

CODE	DESCRIPTION	DIMENSIONS	PRICE
MS99263-XJ	Dual Header Kit (non-lingual)	995mm W 286mm H - 200mm D	51.00 \$

STAND COMPONENTS

1250mm

1250mm PEG REPLACEMENT PANELS

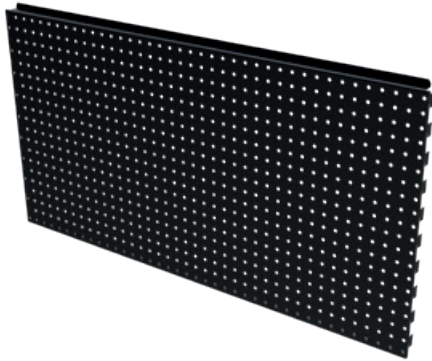

1250MM PEG REPLACEMENT PANELS

CODE	DESCRIPTION	DIMENSIONS	PRICE
MC62394-XJ	1250mm Peg Replacement Panels	1240mm W 500mm H 26mm D	21.68 \$

1250mm SHELF X 486

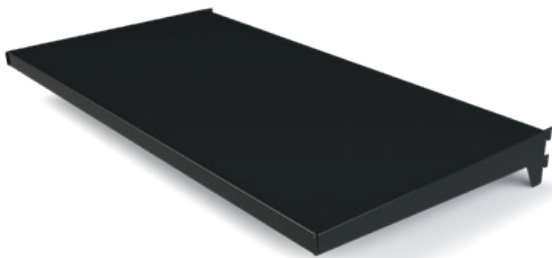

1250MM SHELF X 486

CODE	DESCRIPTION	DIMENSIONS	PRICE
MC62419-XJ	1250mm Shelf x 486	1248mm W 149mm H 511mm D	40.89 \$

1250mm BASE SHELF

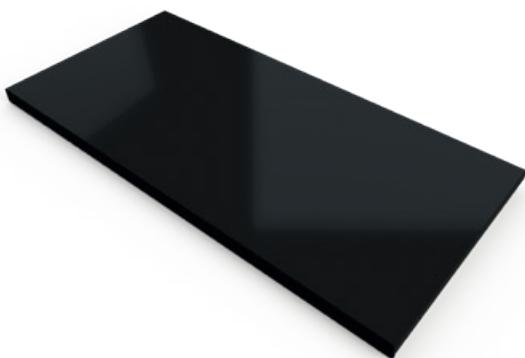

1250MM SHELF X 486

CODE	DESCRIPTION	DIMENSIONS	PRICE
MC62416-XJ	1250mm Base Shelf	1249mm W 34mm H 475mm D	24.40 \$

1250 x 200 PRINTED STANLEY BASE PLINTH PANEL

1250 x 200 PRINTED STANLEY BASE PLINTH PANEL

CODE	DESCRIPTION	DIMENSIONS	PRICE
MC62417-XJ	1250 x 200 Printed Stanley Base Plinth Panel	1249mm W 200mm H 31mm D	9.60 \$



STAND COMPONENTS

1000mm

1000MM PEG REPLACEMENT PANELS

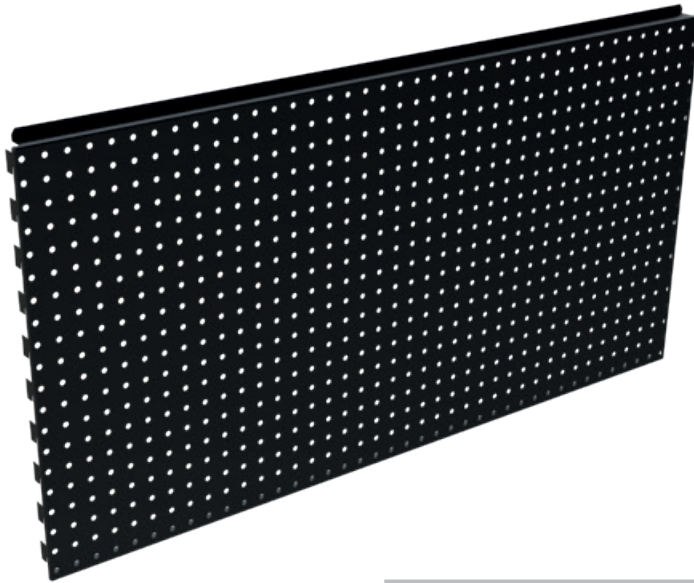

1000MM PEG REPLACEMENT PANELS

CODE	DESCRIPTION	DIMENSIONS	PRICE
STHT8-98813	1000mm Peg Replacement Panels	990mm W 500mm H - 25.5mm D	19.01 \$

1000 X 200 PRINTED STANLEY BASE PLINTH PANEL



1000 x 200 PRINTED STANLEY BASE PLINTH PANEL

CODE	DESCRIPTION	DIMENSIONS	PRICE
STHT8-98819	1000 x 200 Printed Stanley Base Plinth Panel	1000mm W 200mm H - 31mm D	8.49 \$

STAND COMPONENTS

1000mm

1000mm SHELF X 486

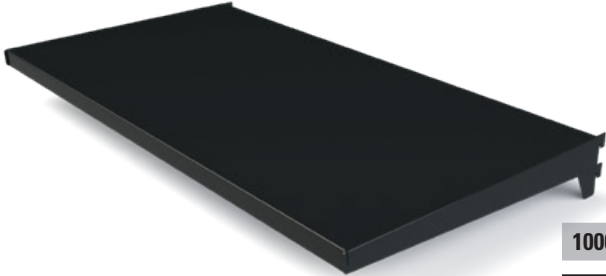

1000mm SHELF X 486

CODE	DESCRIPTION	DIMENSIONS	PRICE
STHT8-98828	1000mm Shelf x 486	998mm W 100mm H 511mm D	34.34 \$

300mm SHELF



300MM SHELF

CODE	DESCRIPTION	DIMENSIONS	PRICE
STHT8-98830	300mm Shelf	300mm W 73mm H 355mm D	18.43 \$

DIVIDER TRAY (WITH 5 ADJUSTABLE DIVIDERS)



DIVIDER TRAY (WITH 5 ADJUSTABLE DIVIDERS)

CODE	DESCRIPTION	DIMENSIONS	PRICE
STHT8-73710	Divider Tray (with 5 adjustable dividers)	996mm W 182mm H 428mm D	34.05 \$

STAND COMPONENTS

1000mm

1-PIECE SHOWCASE



1-PIECE SHOWCASE

CODE	DESCRIPTION	DIMENSIONS	PRICE
STHT8-73711	1-Piece Showcase	996mm W 252mm H - 448mm D	67.37 \$

X20 DIVIDERS (20 PER BAG)



X20 DIVIDERS (20 PER BAG)

CODE	DESCRIPTION	DIMENSIONS	PRICE
STHT8-98836	x20 Dividers (20 per bag)	2mm W 168mm H - 348mm D	11.64 \$

300MM TRAY (WITH 2 ADJUSTABLE DIVIDERS)

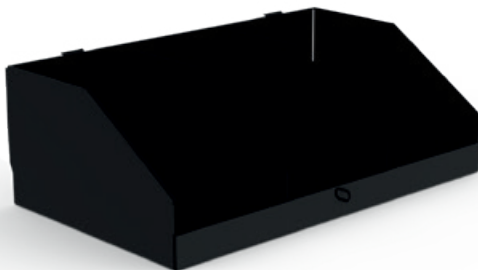

300MM TRAY (WITH 2 ADJUSTABLE DIVIDERS)

CODE	DESCRIPTION	DIMENSIONS	PRICE
STHT8-98833	300mm Tray (with 2 adjustable dividers)	299mm W 190mm H - 365mm D	23.77 \$

STAND COMPONENTS

1000mm

1000MM PERFORATED SCREW DRIVER TRAY



1000MM PERFORATED SCREW DRIVER TRAY

CODE	DESCRIPTION	DIMENSIONS	PRICE
STHT8-98844	1000mm Perforated Screw Driver Tray	999mm W 130mm H 355mm D	71.97 \$

200MM PERFORATED SCREW DRIVER TRAY



200MM PERFORATED SCREW DRIVER TRAY

CODE	DESCRIPTION	DIMENSIONS	PRICE
STHT8-98846	200mm Perforated Screw Driver Tray	200mm W 103mm H 185mm D	10.19 \$

STANLEY ELECTRONIC HANDTOOLS DEMO SHELF



STANLEY ELECTRONIC HANDTOOLS DEMO SHELF

CODE	DESCRIPTION	DIMENSIONS	PRICE
MS99577-XJ	Stanley Electronic Handtools Demo Shelf	998mm W 166mm H 488mm D	38.70 \$

STANLEY LASER SHELF

STANLEY LASER SHELF

CODE	DESCRIPTION	DIMENSIONS	PRICE
MS99553-XJ	Stanley Laser Shelf	185mm W 81mm H 203mm D	7.90 \$

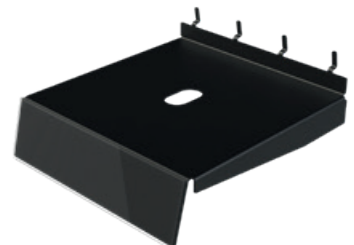

2200MM HIGH LEG SET (UPPER AND LOWER UPRIGHT)

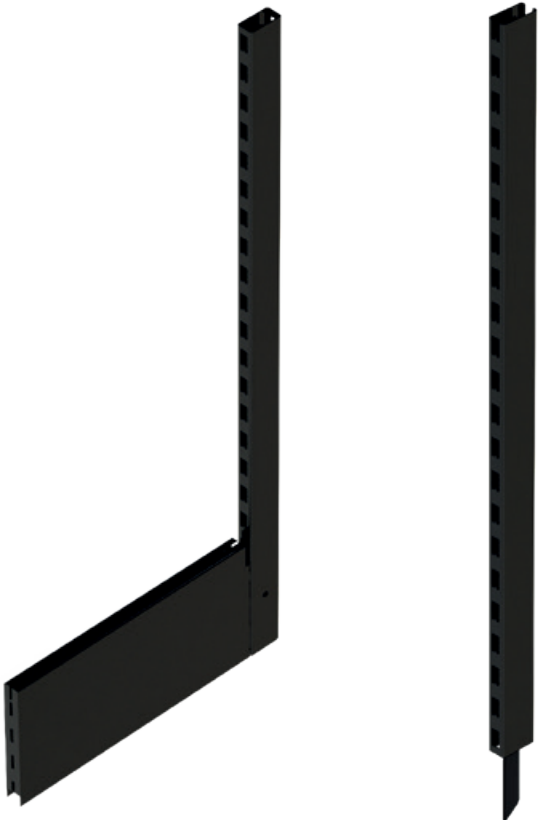

2200MM HIGH LEG SET (UPPER AND LOWER UPRIGHT)

CODE	DESCRIPTION	DIMENSIONS	PRICE
STHT8-98811	2200mm High Leg Set (Upper and Lower Upright)	30mm W 2197mm H - 526mm D	33.27 \$

1000MM BASE SHELF WITH REMOVABLE PANELS

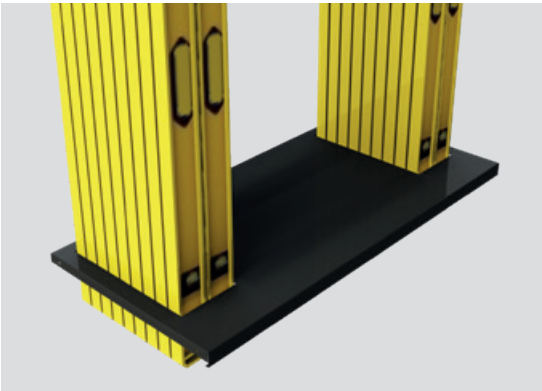
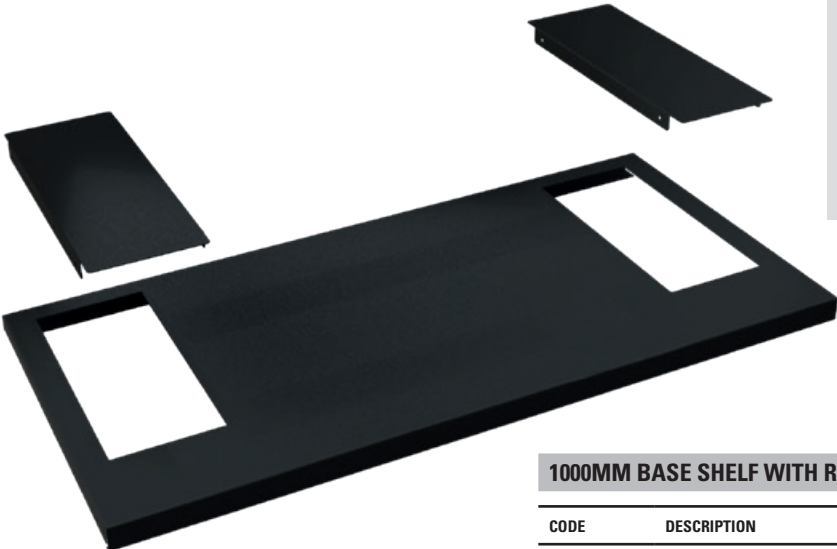

1000MM BASE SHELF WITH REMOVABLE PANELS

CODE	DESCRIPTION	DIMENSIONS	PRICE
STHT8-98817	1000mm Base Shelf with Removable Panels	999mm W 34mm H - 475mm D	21.15 \$

HOOKS & TOOL HOLDERS

STANLEY®



www.stanleytools.com

HOOKS

20X DOUBLE-WIRE EUROHOOK 200MM



20X DOUBLE-WIRE EUROHOOK 200MM

CODE	DESCRIPTION	DIMENSIONS	PRICE
STHT8-98837	20x Double-Wire Eurohook 200mm	28mm W 40mm H 225mm D	7.76 \$

20X DOUBLE-WIRE EUROHOOK 300MM



20X DOUBLE-WIRE EUROHOOK 300MM

CODE	DESCRIPTION	DIMENSIONS	PRICE
STHT8-98838	20x Double-Wire Eurohook 300mm	28mm W 40mm H 325mm D	8.73 \$

20X SINGLE-WIRE HOOK 200MM



20X SINGLE-WIRE HOOK 200MM

CODE	DESCRIPTION	DIMENSIONS	PRICE
STHT8-98839	20x Single-Wire Hook 200mm	35mm W 66mm H 187mm D	8.78 \$

20X SINGLE-WIRE HOOK 300MM



20X SINGLE-WIRE HOOK 300MM

CODE	DESCRIPTION	DIMENSIONS	PRICE
STHT8-98840	20x Single-Wire Hook 300mm	35mm W 66mm H - 287mm D	9.85 \$

10X 300MM SINGLE-WIRE WITH WIDE POS HOLDER



10X 300MM SINGLE-WIRE WITH WIDE POS HOLDER

CODE	DESCRIPTION	DIMENSIONS	PRICE
STHT6-97932	10x 300mm Single-Wire with Wide POS Holder	64mm W 66mm H - 316mm D	5.82 \$

10X 300MM DOUBLE-WIRE EUROHOOK WITH WIDE POS HOLDER



10X 300MM DOUBLE-WIRE EUROHOOK WITH WIDE POS HOLDER

CODE	DESCRIPTION	DIMENSIONS	PRICE
STHT6-97933	10x 300mm Double-Wire Eurohook with Wide POS Holder	64mm W 61mm H - 333mm D	8.73 \$

HOOKS

100X PRICE TAG HOLDER

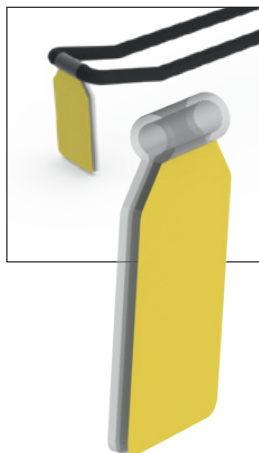

- (100 per bag)
- For 39mm x 26mm Price Tags.

20X DOUBLE-WIRE EUROHOOK 200MM

CODE	DESCRIPTION	DIMENSIONS	PRICE
STHT8-98841	100x Price Tag Holder	30mm W 60mm H 8mm D	19.40 \$

20X 150MM CLAMP HOOK



- (20 per bag)

20X 150MM CLAMP HOOK

CODE	DESCRIPTION	DIMENSIONS	PRICE
STHT8-73712	20x 150mm Clamp Hook	27mm W 82mm H 180mm D	18.43 \$

20X 200MM CLAMP HOOK

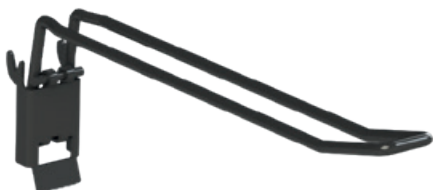

- (20 per bag)

20X SINGLE-WIRE HOOK 200MM

CODE	DESCRIPTION	DIMENSIONS	PRICE
STHT8-73713	20x 200mm Clamp Hook	27mm W 82mm H 230mm D	19.40 \$

WIRE HAMMER BRACKET



WIRE HAMMER BRACKET

CODE	DESCRIPTION	DIMENSIONS	PRICE
STHT8-98847	Wire Hammer Bracket	75mm W 189mm H - 250mm D	7.08 \$

HAMMER HOOKS (PACK OF 20)



HAMMER HOOKS (PACK OF 20)

CODE	DESCRIPTION	DIMENSIONS	PRICE
MS99268-XJ	Hammer Hooks (Pack of 20)	75mm W 189mm H - 166mm D	144.00 \$

VARIABLE WIDTH BRACKET (PAIR)

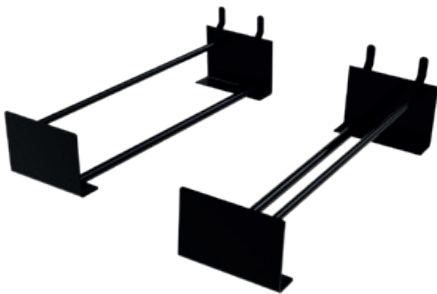

VARIABLE WIDTH BRACKET (PAIR)

CODE	DESCRIPTION	DIMENSIONS	PRICE
STHT8-98848	Variable Width Bracket (Pair)	54mm W 85mm H - 265mm D	9.22 \$

FRENCH 400MM VARIABLE WIDTH BRACKET (PAIR)

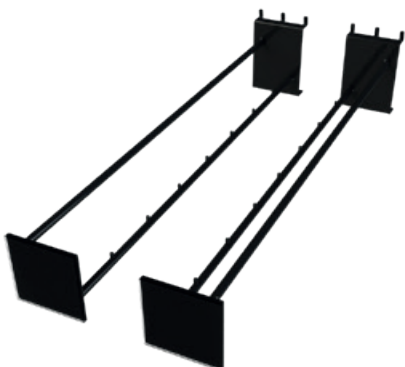

FRENCH 400MM VARIABLE WIDTH BRACKET (PAIR)

CODE	DESCRIPTION	DIMENSIONS	PRICE
MS99462-XJ	French 400mm Variable Width Bracket (Pair)	54mm W 75mm H - 414mm D	7.20 \$

HOOKS

X10 SHORT HOOK



X10 SHORT HOOK

CODE	DESCRIPTION	DIMENSIONS	PRICE
STHT8-98708	x10 Short Hook	65mm W 125mm H 128mm D	18.92 \$

X10 LONG HOOK



X10 LONG HOOK

CODE	DESCRIPTION	DIMENSIONS	PRICE
STHT8-98707	x10 Long Hook	65mm W 132mm H 132mm D	22.80 \$

350MM FRENCH PEGBOARD HOOKS (PACK OF 20)

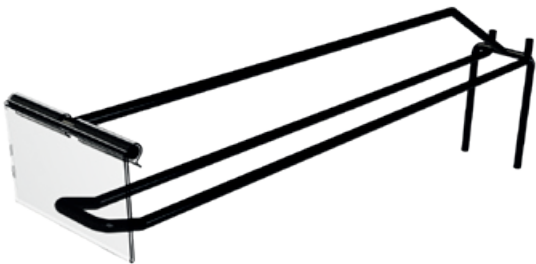

350MM FRENCH PEGBOARD HOOKS (PACK OF 20)

CODE	DESCRIPTION	DIMENSIONS	PRICE
MS99463-XJ	350mm French Pegboard Hooks (pack of 20)	65mm W 145mm H 350mm D	49.40 \$

200MM FRENCH PEGBOARD HOOKS (PACK OF 20)



200MM FRENCH PEGBOARD HOOKS (PACK OF 20)

CODE	DESCRIPTION	DIMENSIONS	PRICE
MS99910-FR	200mm French Pegboard Hooks (pack of 20)	D 65mm W 129.25mm H 199.94mm	\$39.00

TOOL HOLDERS

LARGE ROUND UNIVERSAL TOOL HOLDER



• Supplied as a pair

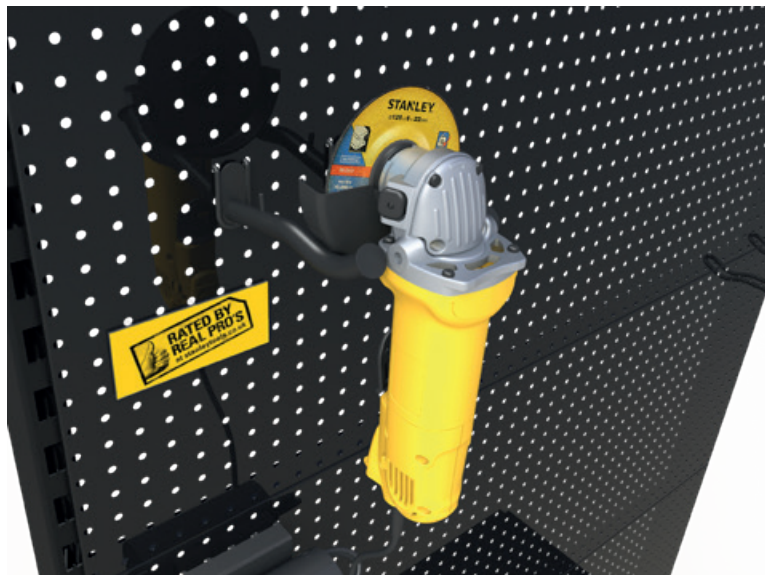

LARGE ROUND UNIVERSAL TOOL HOLDER

CODE	DESCRIPTION	DIMENSIONS	PRICE
MP17875-QZ	Large Round Universal Tool Holder	25mm W 66mm H - 180mm D	3.70 \$

SMALL ROUND UNIVERSAL TOOL HOLDER



• Supplied as a pair

SMALL ROUND UNIVERSAL TOOL HOLDER

CODE	DESCRIPTION	DIMENSIONS	PRICE
MP17874-QZ	Small Round Universal Tool Holder	25mm W 66mm H - 125mm D	3.40 \$

CABLE HOLDER



CABLE HOLDER

CODE	DESCRIPTION	DIMENSIONS	PRICE
MP00663-QZ	Cable Holder	140mm W 93mm H 100mm D	2.34 \$

ANGLE GRINDER HOLDER

- For use with Cordless and Cordless Small / Medium Large Angle Grinders.

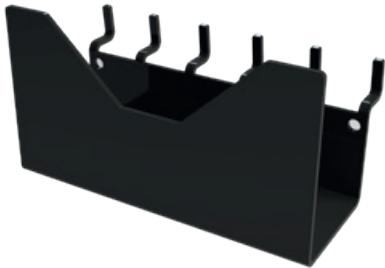

ANGLE GRINDER HOLDER

CODE	DESCRIPTION	DIMENSIONS	PRICE
MP00662-QZ	Angle Grinder Holder	129mm W 73mm H 50mm D	1.66 \$

STANLEY DRILL SHELF



STANLEY DRILL SHELF

CODE	DESCRIPTION	DIMENSIONS	PRICE
MS99714-QZ	STANLEY Drill Shelf	193mm W 276mm H 348mm D	8.52 \$

DRILLS & SDS PLUS HOLDER

- For use with cordless Drill Driver / Hammer Drill / Driver / Right Angle Drills
- SDS- Plus Rotary Hammer Drills and corded SDS-Plus Rotary Hammer Drills
- Rotary Drills and Percussion Drills.



DRILLS & SDS PLUS HOLDER

CODE	DESCRIPTION	DIMENSIONS	PRICE
MP00658-QZ	Drills & SDS Plus Holder	104mm W 93mm H - 31mm D	1.44 \$

CORDLESS HOLDER

- For use with Drill Drivers / Hammer Drill / Drivers / Impact Drivers
- Impact Wrenches / Reciprocating Saws / Nailers.

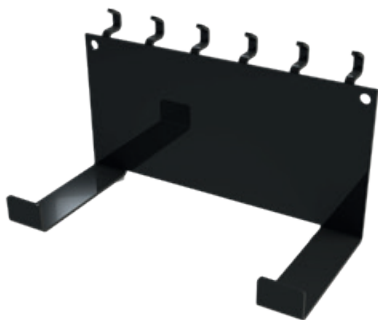

CORDLESS HOLDER

CODE	DESCRIPTION	DIMENSIONS	PRICE
MP00659-QZ	Cordless Holder	150mm W 87mm H - 74mm D	1.17 \$

ACRYLIC TOOL HOLDER (PACK OF 6)



ACRYLIC TOOL HOLDER (PACK OF 6)

CODE	DESCRIPTION	DIMENSIONS	PRICE
MS99334-XJ	Acrylic Tool Holder (pack of 6)	70mm W 113mm H - 63mm D	6.50 \$

CIRCULAR SAW SHELF

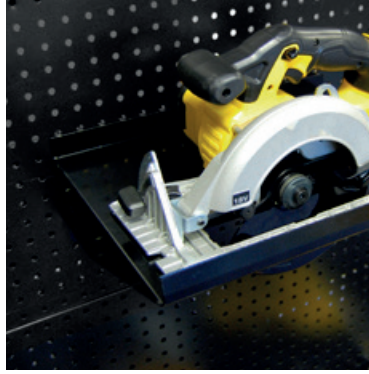
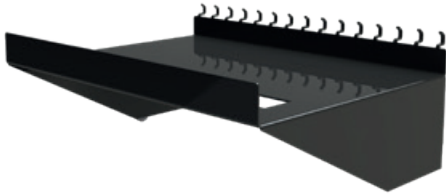

- For use with Cordless and Coded Portable Circular Saws.

CIRCULAR SAW SHELF

CODE	DESCRIPTION	DIMENSIONS	PRICE
MP00661-QZ	Circular Saw Shelf	373mm W 102mm H 286mm D	7.08 \$

200X160 FLAT SHELF



- For use with Corded Portable Tools.

200X160 FLAT SHELF

CODE	DESCRIPTION	DIMENSIONS	PRICE
MP00662-QZ	200x160 Flat Shelf	203mm W 88mm H 172mm D	2.89 \$

CORDLESS IMPACT DRIVER HOLDER



CORDLESS IMPACT DRIVER HOLDER

CODE	DESCRIPTION	DIMENSIONS	PRICE
MP00722-QZ	Cordless Impact Driver Holder	154mm W 45mm H 60mm D	1.70 \$

PRODUCT DISPLAY POSTS



- For use with cordless Drill Driver / Hammer Drill / Driver / Right Angle Drills
- SDS- Plus Rotary Hammer Drills and corded SDS-Plus Rotary Hammer Drills
- Rotary Drills and Percussion Drills.

PRODUCT DISPLAY POSTS (PACK OF 10)

CODE	DESCRIPTION	DIMENSIONS	PRICE
MC04176-XJ	Product Display Posts (pack of 10)	20mm W 67mm H - 20mm D	10.19 \$

ANGLED PRODUCT DISPLAY POSTS



- For use with Drill Drivers / Hammer Drill / Drivers / Impact Drivers
- Impact Wrenches / Reciprocating Saws / Nailers.

ANGLED PRODUCT DISPLAY POSTS (PACK OF 10)

CODE	DESCRIPTION	DIMENSIONS	PRICE
MC04177-XJ	Angled Product Display Posts (pack of 10)	65mm W 90mm H - 83mm D	10.67 \$

SMALL DRILL HOLDER



SMALL DRILL HOLDER

CODE	DESCRIPTION	DIMENSIONS	PRICE
MC03992-XJ	Small Drill Holder	100mm W 62mm H - 56mm D	1.12 \$

SAW RACK HOLDER - 10 X SAWS

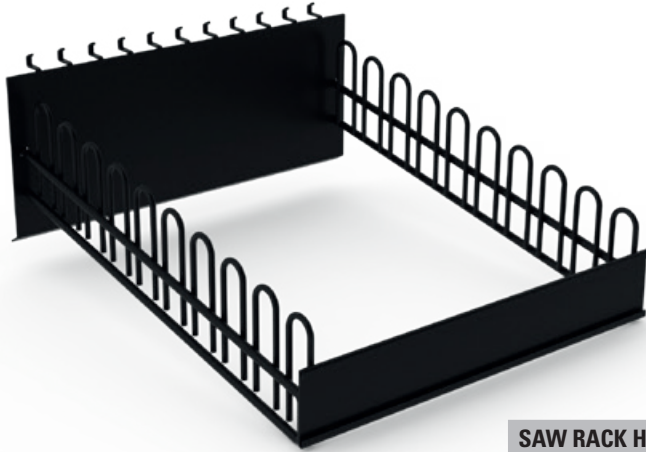

SAW RACK HOLDER - 10 X SAWS

CODE	DESCRIPTION	DIMENSIONS	PRICE
MS99804-XJ	Saw Rack Holder - 10 x Saws	300mm W 128mm H 326mm D	11.95 \$

WIRE SAW RACK - 8 X SAWS

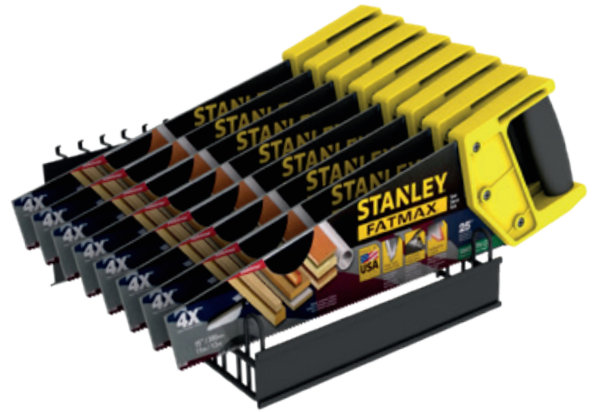
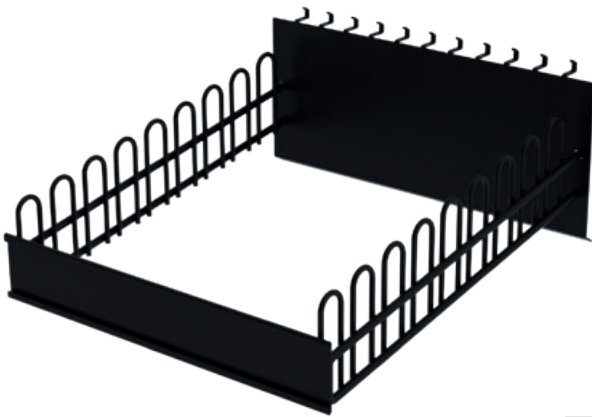

WIRE SAW RACK - 8 X SAWS

CODE	DESCRIPTION	DIMENSIONS	PRICE
STHT8-98853	Wire Saw Rack - 8 x Saws	300mm W 125mm H 300mm D	7.37 \$

WIRE SAW RACK - 4 X SAWS

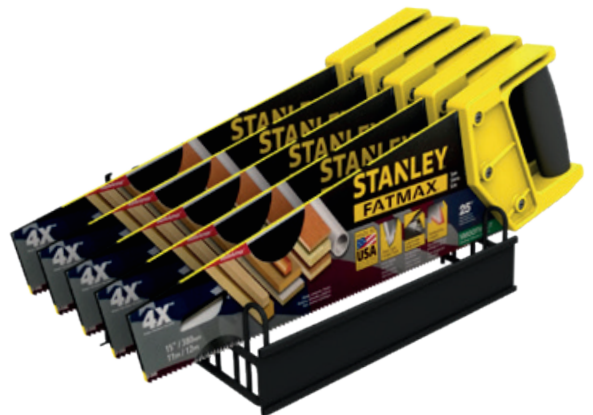

WIRE SAW RACK - 4 X SAWS

CODE	DESCRIPTION	DIMENSIONS	PRICE
STHT8 - 98854	Wire Saw Rack - 4 x Saws	300mm W 125mm H 180mm D	5.48 \$

TIMBER POST FOR TRIGGER CLAMP



TIMBER POST FOR TRIGGER CLAMP

CODE	DESCRIPTION	DIMENSIONS	PRICE
MS99087-XJ	Timber Post for Trigger Clamp	54mm W 70mm H - 203mm D	6.27 \$

METAL BRACKET FOR TRIGGER CLAMP

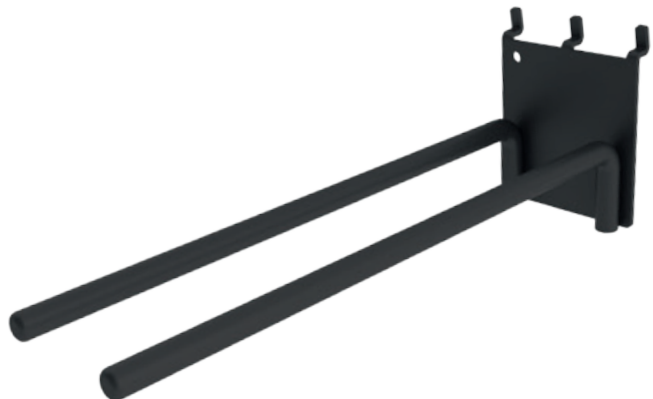

METAL BRACKET FOR TRIGGER CLAMP

CODE	DESCRIPTION	DIMENSIONS	PRICE
MS99088-XJ	Metal Bracket for Trigger Clamp	54mm W 70mm H - 210mm D	1.84 \$

IN-FIXTURE PLIERS DISPLAY

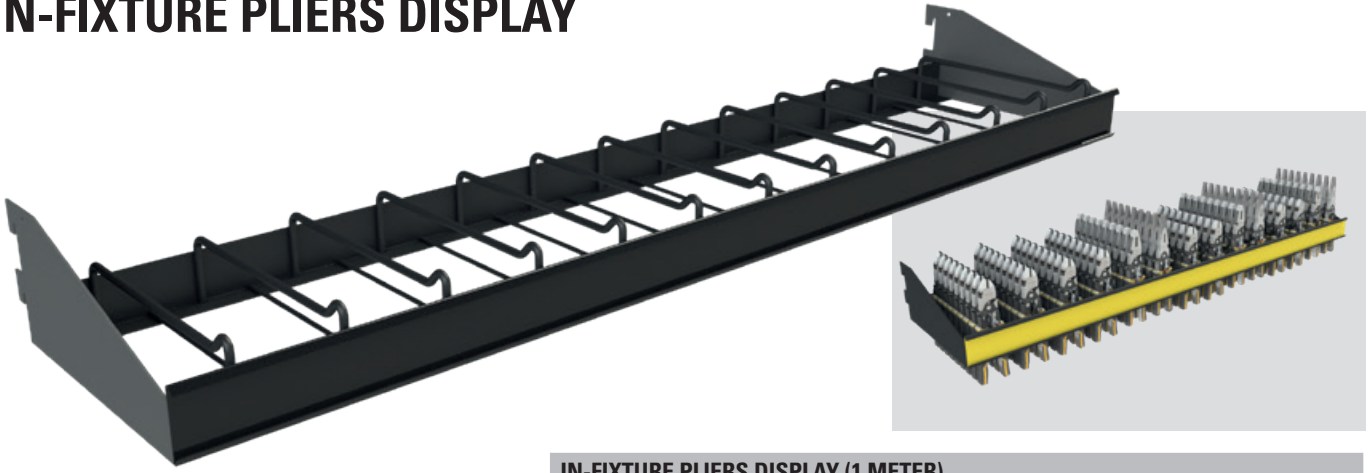

IN-FIXTURE PLIERS DISPLAY (1 METER)

CODE	DESCRIPTION	DIMENSIONS	PRICE
MS99310-XJ	In-Fixture Pliers Display (1 Meter)	996mm W 100mm H 239mm D	27.00 \$

IN-FIXTURE PLIERS DISPLAY

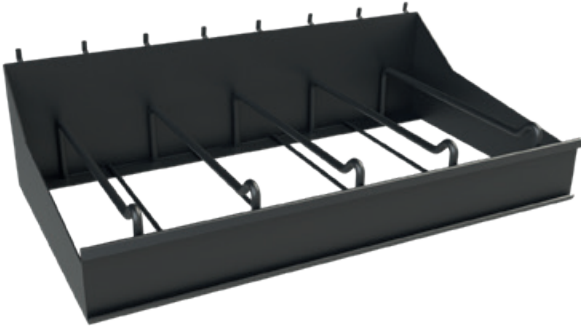

IN-FIXTURE PLIERS DISPLAY

CODE	DESCRIPTION	DIMENSIONS	PRICE
MS99311-XJ	In-Fixture Pliers Display (Small)	376mm W 100mm H 207mm D	9.00 \$

RETRACTABLE SECURITY TETHER - LOOPED



RETRACTABLE SECURITY TETHER - LOOPED (PACK OF 5)

CODE	DESCRIPTION	DIMENSIONS	PRICE
MS99515-XJ	Retractable Security Tether - Looped (pack of 5)	33mm W 17mm H 51mm D	8.00 \$

RETRACTABLE SECURITY TETHER - LARGE EYELET



RETRACTABLE SECURITY TETHER - LARGE EYELET (PACK OF 5)

CODE	DESCRIPTION	DIMENSIONS	PRICE
MS99514-XJ	Retractable Security Tether - Large Eyelet (pack of 5)	33mm W 17mm H 51mm D	8.00 \$

SECURITY TETHER NON-RETRACTABLE



SECURITY TETHER NON-RETRACTABLE

CODE	DESCRIPTION	DIMENSIONS	PRICE
MP00665-QZ	Security Tether Non-Retractable	232mm W 167mm H - 120mm D	3.40 \$

RETRACTABLE SECURITY TETHER - SMALL EYELET



RETRACTABLE SECURITY TETHER - SMALL EYELET (PACK OF 5)

CODE	DESCRIPTION	DIMENSIONS	PRICE
MS99513-XJ	Retractable Security Tether - Small Eyelet (pack of 5)	33mm W 17mm H - 51mm D	8.00 \$

BATTERY ANTI-THEFT DEVICE



BATTERY ANTI-THEFT DEVICE (PACK OF 20)

CODE	DESCRIPTION	DIMENSIONS	PRICE
MS99412-XJ	Battery Anti-Theft Device (pack of 20)	52mm W 42mm H - 18mm D	8.40 \$

SMALL SOCKET SET TRAY (NON-LINGUAL)



SMALL SOCKET SET TRAY (NON-LINGUAL)

CODE	DESCRIPTION	DIMENSIONS	PRICE
MS99818-XJ	Small Socket Set Tray (Non-Lingual)	270mm W 245mm H 135mm D	28.50 \$

MEDIUM SOCKET SET TRAY (NON-LINGUAL)



MEDIUM SOCKET SET TRAY (NON-LINGUAL)

CODE	DESCRIPTION	DIMENSIONS	PRICE
MS99819-XJ	Medium Socket Set Tray (Non-Lingual)	325mm W 315mm H 140mm D	37.00 \$

LARGE SOCKET SET TRAY



LARGE SOCKET SET TRAY (NON-LINGUAL)

CODE	DESCRIPTION	DIMENSIONS	PRICE
MS99820-XJ	Large Socket Set Tray (Non-Lingual)	450mm W 405mm H - 145mm D	53.00 \$

EXTRA LARGE SOCKET SET TRAY



EXTRA LARGE SOCKET SET TRAY (NON-LINGUAL)

CODE	DESCRIPTION	DIMENSIONS	PRICE
MS99821-XJ	Extra Large Socket Set Tray (Non-Lingual)	550mm W 450mm H - 131mm D	67.00 \$

TRACKWALL SYSTEM

STANLEY TRACKWALL SYSTEM

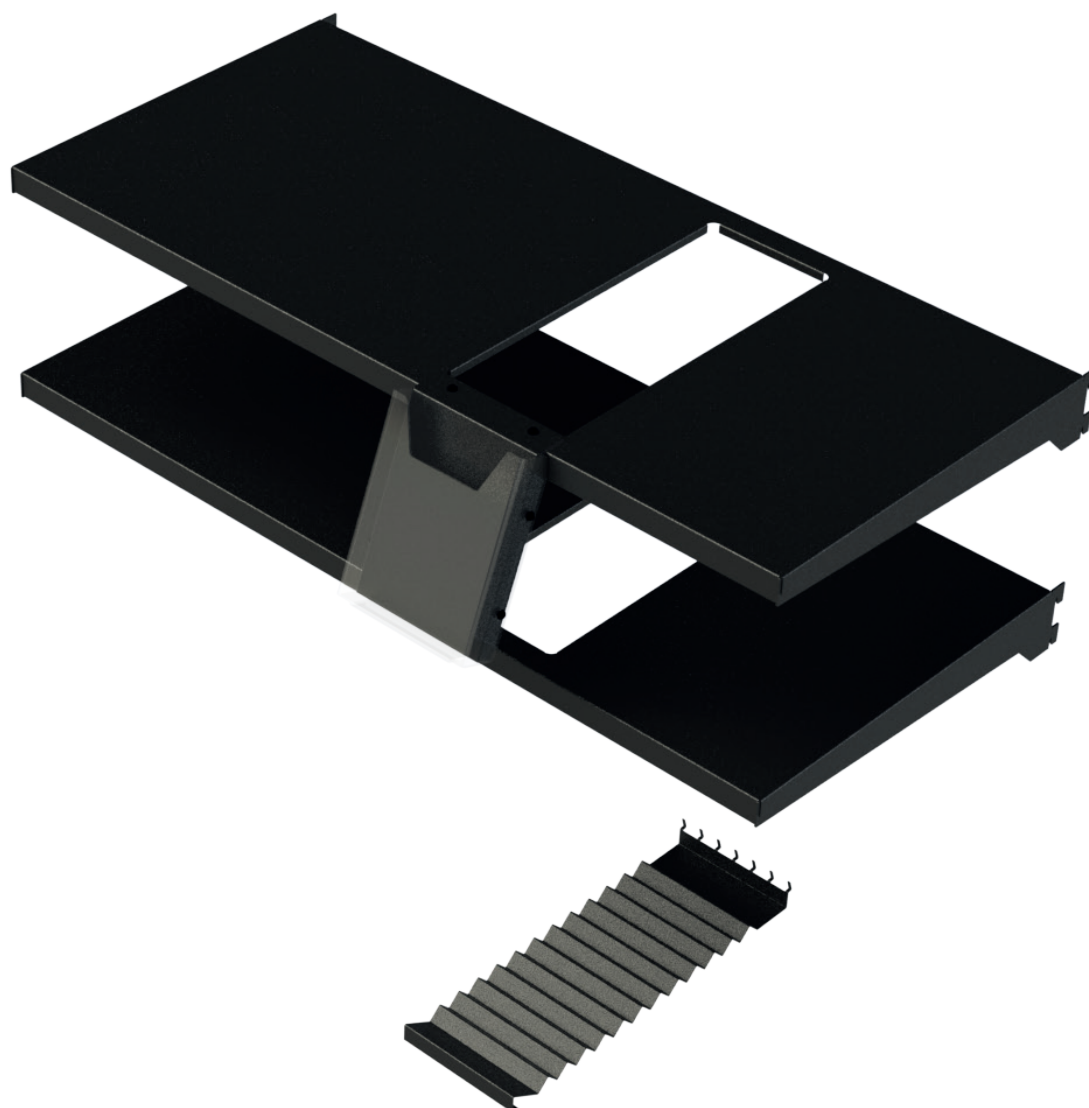

STANLEY TRACKWALL SYSTEM

CODE	DESCRIPTION	DIMENSIONS	PRICE
MS99656-XJ	STANLEY Trackwall System	997mm W 540mm H 577mm D	80.00 \$

STANLEY



STANLEY Trackwall System
MS99656-XJ

COMMUNICATIO

N



GRAPHIC & LEAFLET HOLDERS

LEAFLET PANEL A4

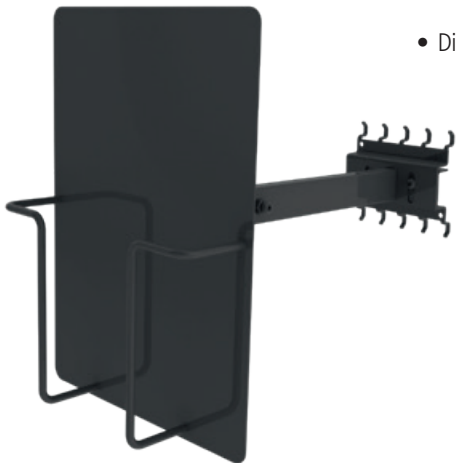

- Displays A4 brochure on fixture.

LEAFLET PANEL A4

CODE	DESCRIPTION	DIMENSIONS	PRICE
MC03986-XJ	Leaflet Panel A4	230mm W 315mm H 274mm D	8.54 \$

MAGNETIC GRAPHIC HOLDER FOR A8 INFO CARDS



- Graphics supplied separately

MAGNETIC GRAPHIC HOLDER FOR A8 INFO CARDS

CODE	DESCRIPTION	DIMENSIONS	PRICE
MC03988-XJ	Magnetic Graphic Holder for A8 Info Cards	74mm W 52mm H 5mm D	0.53 \$

A-FRAME



A-FRAME (NON-LINGUAL)

CODE	DESCRIPTION	DIMENSIONS	PRICE
MS99578-XJ	A-Frame (Non-Lingual)	600mm W 1000mm H 530mm D	66.50 \$

ECONOMICAL TELESCOPIC GRAPHIC HOLDER

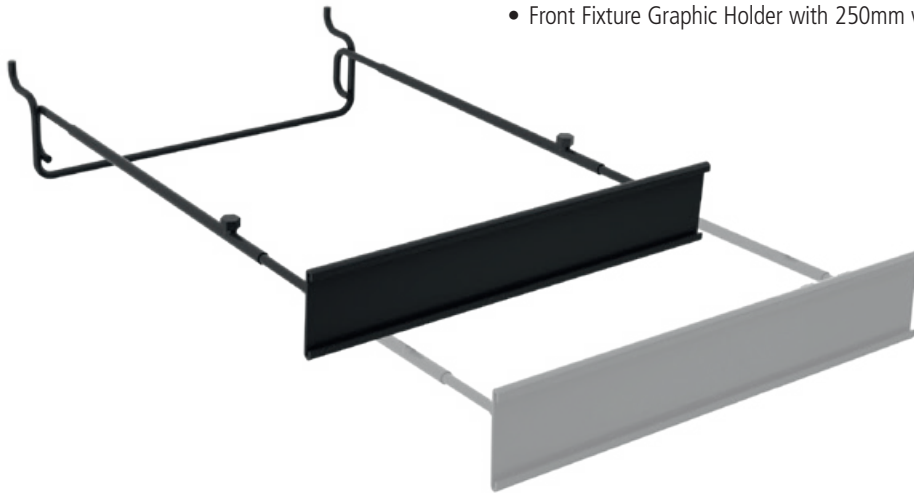

- Front Fixture Graphic Holder with 250mm wide channels.

ECONOMICAL TELESCOPIC GRAPHIC HOLDER

CODE	DESCRIPTION	DIMENSIONS	PRICE
STHT8-98843	Economical Telescopic Graphic Holder	250mm W 90mm H - 450/300mm D	5.87 \$

LARGE CATEGORY DIVIDER

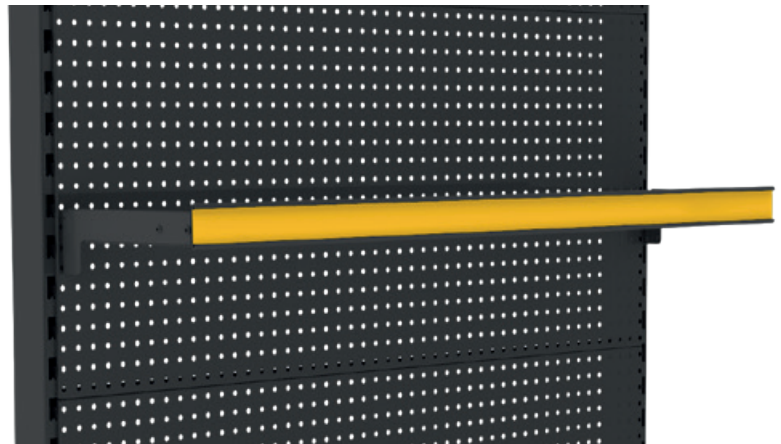

- 1m-Wide horizontal graphic holder. Strip height 47mm
- Graphics supplied separately



LARGE CATEGORY DIVIDER

CODE	DESCRIPTION	DIMENSIONS	PRICE
MA00623-QZ	Large Category Divider	996mm W 83mm H - 242mm D	11.40 \$

COMMUNICATION

ADJUSTABLE DEPTH BUS STOP



- Graphics supplied separately

- Telescopic, easy-install transparent graphic holders display A4 inserts in
- landscape or portrait format / 1-high or 2-high from any position on fixture uprights.
- For category management or promotional communication.
- Includes 2 x A4 Graphic Holders (Graphics Not Included)



ADJUSTABLE DEPTH BUS STOP

CODE	DESCRIPTION	DIMENSIONS	PRICE
MC04001-XJ	Adjustable Depth Bus Stop	260mm W 800mm H 30mm D	6.60 \$

STANLEY BAG OF 8 CLIPS



STANLEY BAG OF 8 CLIPS (NON-LINGUAL)

CODE	DESCRIPTION	DIMENSIONS	PRICE
MS99594-XJ	STANLEY Bag of 8 Clips (Non-Lingual)	20mm W 20mm H 15mm D	0.74 \$

STANLEY AUTOMOTIVE FLEXIBLE BUS STOP

STANLEY AUTOMOTIVE FLEXIBLE BUS STOP

CODE	DESCRIPTION	DIMENSIONS	PRICE
MS99468-XJ	STANLEY Automotive Flexible Bus Stop	25mm W 879mm H - 410mm D	18.00 \$



STANLEY FLEXIBLE BUS STOP

CODE	DESCRIPTION	DIMENSIONS	PRICE
MS99581-XJ	STANLEY Flexible Bus Stop	25mm W 879mm H - 410mm D	18.00 \$

STANLEY BUS STOP BRACKETS



STANLEY BUS STOP BRACKETS

CODE	DESCRIPTION	DIMENSIONS	PRICE
MS99576-XJ	Stanley Bus Stop Brackets	115mm W 879mm H - 45.40mm D	14.00 \$

GENERIC IN-FIXTURE HIGHLIGHTER DISPLAY



GENERIC IN-FIXTURE HIGHLIGHTER DISPLAY

CODE	DESCRIPTION	DIMENSIONS	PRICE
MS99538-XJ	Generic In-Fixture Highlighter Display	300-990mm W 83mm H - 242mm D	44.00 \$

VIDEO MERCHANDISING

12" HD HEAVY DUTY FRAME

Includes

- 12" LCD Screen
- 4GB SD Card
- Rapid and secure fixing in prime promotional positions;
 - To cross-bars with special steel clamps
 - To any steel structure with heavy-duty cable ties
 - To walls with keyhole screw fixing
- Lightweight 1-piece durable structure with black epoxy coating.
- Hooks not included



12" HD HEAVY DUTY FRAME			
CODE	DESCRIPTION	DIMENSIONS	PRICE
MS99146-XJ	12" HD Heavy Duty Frame	450mm W 1561mm H 170mm D	250.46 \$

IN FIXTURE TV SCREEN - FLUSH MOUNTING



IN FIXTURE TV SCREEN - FLUSH MOUNTING

CODE	DESCRIPTION	DIMENSIONS	PRICE
MC04180-XJ	In Fixture TV Screen - Flush Mounting	337mm W 265mm H - 164mm D	101.85 \$

12" HD UNIVERSAL BAR



Includes

- 12" LCD Screen
- 4GB SD Card
- Durable structure designed for long life-span in demanding DIY and trade environments.
- Fits to any fixture with slotted uprights: 1m, 1.2m or 900mm.
- Adjusts vertically and horizontally to position video anywhere in prime promotional positions.
- Rapid, secure fixing with heavy duty, secure steel case.
- Angled screen and compact dimensions provides high visibility without stock reduction.
- Hooks not included

12" HD UNIVERSAL BAR

CODE	DESCRIPTION	DIMENSIONS	PRICE
MS99147-XJ	12" HD Universal Bar	900-1200mm W 432mm H - 445mm D	219.46 \$

SPECIAL ORDER ITEMS



STANLEY
ATMAX

DEPENDABILITY
MATTERS.

V20
LITHIUM ION



STANLEY

STANLEY V20 ISLAND

STANLEY V20 ISLAND



- Includes graphic as shown

STANLEY V20 ISLAND

CODE	DESCRIPTION	DIMENSIONS	PRICE
V20/2834 V20 Island	Stanley V20 Island	2968mm W 2167mm H 950mm D	982.00 \$

V20 1.25m END BAY ADD ON

V20 1.25m END BAY ADD ON



- Includes graphic as shown

V20 1.25M END BAY ADD ON

CODE	DESCRIPTION	DIMENSIONS	PRICE
V20/2834	V20 1.25m End Bay Add On	1246mm W 836mm H - 500mm D	175.00 \$



www.voxsp.com

6, Beaumont Gate, Radlett
WD7 7AR England
tel +44 (0)1923 858525
fax +44 (0)1923 858526
info@voxsp.com

STANLEY®

Stanley Black & Decker
Europe, Middle East & Africa Headquarters
De Kleetlaan 5BC
1831 Diegem – Belgium
Telephone: +32 2 402 02 00